



REPUBLIKA SLOVENIJA  
MINISTRSTVO ZA FINANCE

FINANČNA UPRAVA REPUBLIKE SLOVENIJE

Generalni finančni urad

Šmartinska cesta 55, p.p. 631, 1001 Ljubljana

T: 01 478 38 00

F: 01 478 39 00

E: [gfu.fu@gov.si](mailto:gfu.fu@gov.si)

[www.fu.gov.si](http://www.fu.gov.si)

# Davčno potrjevanje računov / *Fiscal verification of invoices*

TEHNIČNE SPECIFIKACIJE / *TECHNICAL SPECIFICATIONS*

Verzija 1.2 / *Version 1.2*



### Identifikacija dokumenta / *Document identification*

Naziv dokumenta / <i>Name of the document:</i>	<b>Tehnične specifikacije za davčno potrjevanje računov /</b> <b><i>Technical specifications for fiscal verification of invoices</i></b>
Zadnja sprememba / <i>Last change</i>	21.9.2015
Verzija in status / <i>Version and status</i>	V1.2, Delovna verzija / <i>V1.2, Working document</i>
Priloge / <i>Annexes</i>	

### Spremembe dokumenta

Verzija / <i>Version</i>	Datum / <i>Date</i>	Opis dopolnitev in/ali referenčna oznaka poglavja / <i>Description of additions and/or reference mark of the chapter</i>
1.0	<b>1.9.2015</b>	Prva verzija / <i>First version</i>
1.1.	<b>4.9.2015</b>	Odpravljena napaka v C# primeru izračuna ZOI. / <i>Error fixed in C# case of ZOI calculation</i>  Popravljen JSON shema (element AmountType) / <i>Corrected JSON schema (element AmountType)</i>
1.2	<b>21.9.2015</b>	Tabela o vsebini in obliki sporočil je dopolnjena z XML elementi (poglavji 3.1.1. in 3.2.1.) / <i>Table on the content and form of messages is completed with XML elements (chapters 3.1.1. and 3.2.1.)</i>  Dodan opis TLS (poglavje 2) / <i>TLS description is added (Chapter 2)</i>  Dodan angleški prevod / <i>English translation is added</i>



## Vsebina / Content

1. UVOD / INTRODUCTION.....	6
2. DIGITALNA POTRDILA (PUBLIC KEY INFRASTRUCTURE) / DIGITAL CERTIFICATES (PUBLIC KEY INFRASTRUCTURE).....	7
2.2. POSTOPEK PRIDOBIVANJA PRODUKCIJSKIH DIGITALNIH POTRDIL/JAVNIH KLJUČEV / PROCEDURE FOR ACQUIRING PRODUCTION DIGITAL CERTIFICATES/PUBLIC KEYS .....	8
2.3. POSTOPEK PREKLICA DIGITALNIH POTRDIL / PROCEDURE FOR WITHDRAWAL OF DIGITAL CERTIFICATES.....	9
2.4. POSTOPEK PRIDOBIVANJA TESTNIH DIGITALNIH POTRDIL / PROCEDURE FOR ACQUIRING TEST DIGITAL CERTIFICATES.....	10
3. VRSTE POSLOVNIH SPOROČIL / TYPES OF BUSINESS MESSAGES.....	11
3.1. RAČUN / INVOICE.....	11
3.1.1. VSEBINA IN OBLIKA SPOROČILA TIPA RAČUN / CONTENT AND FORM OF THE MESSAGE OF THE INVOICE TYPE.....	13
3.1.2. SHEMA SPOROČILA TIPA RAČUN / SCHEMA OF THE MESSAGE OF THE INVOICE TYPE.....	57
3.1.3. PRIMER SPOROČILA TIPA RAČUN IZDANEGA PREKO ELEKTRONSKE NAPRAVE / EXAMPLE OF THE MESSAGE OF THE INVOICE TYPE ISSUED VIA THE ELECTRONIC DEVICE.....	59
3.1.4. PRIMER SPOROČILA TIPA RAČUN IZDANEGA PREKO VEZANE KNJIGE RAČUNOV / EXAMPLE OF THE MESSAGE OF THE INVOICE TYPE ISSUED VIA THE PRE-NUMBERED INVOICE BOOK.....	60
3.1.5. VSEBINA IN OBLIKA ODGOVORA NA SPOROČILO TIPA RAČUN / CONTENT AND FORM OF THE RESPONSE TO THE MESSAGE OF THE INVOICE TYPE.....	61
3.1.6. SHEMA ODGOVORA NA SPOROČILO TIPA RAČUN / SCHEMA OF THE RESPONSE TO THE MESSAGE OF THE INVOICE TYPE.....	62
3.1.7. PRIMER ODGOVORA NA SPOROČILO TIPA RAČUN / EXAMPLE OF THE RESPONSE TO THE MESSAGE OF THE INVOICE TYPE.....	63
3.2. PODATKI O POSLOVNEM PROSTORU / DATA ABOUT BUSINESS PREMISES.....	64
3.2.1. VSEBINA IN OBLIKA SPOROČILA TIPA POSLOVNI PROSTOR / CONTENT AND FORM OF THE MESSAGE OF THE BUSINESS PREMISES TYPE.....	65
3.2.2. SHEMA SPOROČILA TIPA POSLOVNI PROSTOR / SCHEMA OF THE MESSAGE OF THE BUSINESS PREMISES TYPE.....	71
3.2.3. PRIMER SPOROČILA TIPA POSLOVNI PROSTOR / EXAMPLE OF THE MESSAGE OF THE BUSINESS PREMISES TYPE.....	72

3.2.4. VSEBINA IN OBLIKA ODGOVORA NA SPOROČILO TIPA POSLOVNI PROSTOR / CONTENT AND FORM OF THE RESPONSE TO THE MESSAGE OF THE BUSINESS PREMISES TYPE.....	73
3.2.5. SHEMA ODGOVORA NA SPOROČILO TIPA POSLOVNI PROSTOR / SCHEMA OF THE RESPONSE TO THE MESSAGE OF THE BUSINESS PREMISES TYPE.....	73
3.2.6. PRIMER ODGOVORA NA SPOROČILO TIPA POSLOVNI PROSTOR / EXAMPLE OF THE RESPONSE TO THE MESSAGE OF THE BUSINESS PREMISES TYPE.....	74
3.3. SPOROČILO TIPA »ECHO« / MESSAGE OF THE ECHO TYPE.....	75
3.3.1. PRIMER SPOROČILA TIPA »ECHO« / EXAMPLE OF THE ECHO TYPE MESSAGE.....	75
3.3.2. PRIMER ODGOVORA NA SPOROČILO TIPA »ECHO« / EXAMPLE OF THE RESPONSE TO THE ECHO TYPE MESSAGE.....	75
4. ŠIFRANT NAPAK / ERROR CODE TABLE.....	76
5. ELEKTRONSKI PODPIS SPOROČIL V XML OBLIKI / ELECTRONIC SIGNATURE OF MESSAGES IN XML FORM.....	78
6. POSTOPEK POVEZOVANJA ZAVEZANCEV NA IS FINANČNE UPRAVE / PROCEDURE FOR CONNECTING PERSONS LIABLE WITH THE INFORMATION SYSTEM OF THE FINANCIAL ADMINISTRATION.....	82
6.1. NASLOVI ZA POVEZOVANJE NA IS FINANČNE UPRAVE / ADDRESSES FOR CONNECTING TO THE INFORMATION SYSTEM OF THE FINANCIAL ADMINISTRATION.....	82
7. PRIMERI SPOROČIL V XML OBLIKI / EXAMPLES OF MESSAGES IN XML FORM.....	84
7.1. PRIMER RAČUNA V XML OBLIKI S PODPISOM / EXAMPLE OF THE INVOICE IN XML FORM WITH THE SIGNATURE.....	84
7.2. PRIMER ODGOVORA NA RAČUN V XML OBLIKI S PODPISOM / EXAMPLE OF THE RESPONSE TO THE INVOICE IN XML FORM WITH THE SIGNATURE.....	85
7.3. PRIMER PRIJAVE POSLOVNEGA PROSTORA V XML OBLIKI S PODPISOM / EXAMPLE OF REPORTING BUSINESS PREMISES IN XML FORM WITH THE SIGNATURE.....	86
7.4. PRIMER ODGOVORA NA PRIJAVO POSLOVNEGA PROSTORA S PODPISOM / EXAMPLE OF THE RESPONSE TO THE REPORT OF BUSINESS PREMISES WITH THE SIGNATURE.....	87
7.5. PRIMER ODGOVORA Z NAPAKO IN PODPISOM V XML OBLIKI NA SPOROČILO TIPA RAČUN / EXAMPLE OF THE RESPONSE WITH AN ERROR AND SIGNATURE IN XML FORM TO THE MESSAGE OF THE INVOICE TYPE.....	89
7.6. PRIMER ODGOVORA Z NAPAKO IN PODPISOM V XML OBLIKI NA SPOROČILO TIPA POSLOVNI PROSTOR / EXAMPLE OF THE RESPONSE WITH AN ERROR AND SIGNATURE IN XML FORM TO THE MESSAGE OF THE BUSINESS PREMISES TYPE.....	90
8. SPOROČILA V JSON OBLIKI / MESSAGES IN JSON FORM.....	92
8.1. JWS HEADER.....	92
9. PRIMERI SPOROČIL V JSON OBLIKI / EXAMPLES OF MESSAGES IN JSON OBLIKI.....	94
9.1. PRIMER RAČUNA IZDANEGA PREKO ELEKTRONSKE NAPRAVE / EXAMPLE OF THE INVOICE ISSUED VIA THE ELECTRONIC DEVICE.....	94
9.2. PRIMER RAČUNA IZDANEGA PREKO VEZANE KNJIGE RAČUNOV / EXAMPLE OF THE INVOICE ISSUED VIA THE PRE-NUMBERED INVOICE BOOK.....	96
9.3. PRIMER ODGOVORA NA RAČUN / EXAMPLE OF THE RESPONSE TO THE INVOICE.....	98

9.4. PRIMER PRIJAVE PROSTORA / <i>EXAMPLE FOR REPORTING PREMISES</i> .....	99
9.5. PRIMER ODGOVORA NA PRIJAVO PROSTORA / <i>EXAMPLE OF THE RESPONSE TO PREMISES REPORT</i> .....	102
9.6. PRIMER NAPAKE / <i>EXAMPLE OF AN ERROR</i> .....	103
9.7. PRIMER SPOROČILA TIPA »ECHO« / <i>EXAMPLE OF »ECHO« TYPE MESSAGE</i> .....	104
9.8. PRIMER ODGOVORA NA SPOROČILO TIPA »ECHO« / <i>EXAMPLE OF THE RESPONSE TO »ECHO« TYPE MESSAGE</i> .....	104
10. ZAŠČITNA OZNAKA IZDAJATELJA RAČUNA / <i>PROTECTIVE MARK OF THE INVOICE ISSUER</i> ...	105
10.1. PRIMER JAVA / <i>JAVA EXAMPLE</i> .....	106
10.2. PRIMER .NET (C#).....	107

# 1. UVOD / INTRODUCTION

V tem dokumentu je opisan način povezovanja med davčnimi zavezanci ter informacijskim sistemom finančne uprave za namene potrjevanja računov. Dokument je namenjen vsem zainteresiranim razvijalcem, ki bodo sodelovali pri realizaciji potrjevanja računov na strani zavezancev. / *This document describes the method for connecting taxpayers and financial administration's information system for purposes of invoice verification. Document is intended for all interested software developers, who will participate in realisation of invoice verification on behalf of taxpayers.*

Dokument zajema vsa sporočila za izmenjavo podatkov, procese za izmenjavo, definirani so podatkovni sklopi in pravila, ki jih je potrebno upoštevati pri komunikaciji. / *The document includes all messages for data exchange, processes for exchange, data sets and rules, which shall be taken into consideration at communication, are defined.*

Izmenjava podatkov se izvaja preko spletne storitve v formatu XML ali JSON. S tem je zagotovljen od tehnologije neodvisen način izmenjave podatkov med zavezanci in FURS. / *Exchange of data is performed via the web service in the XML format or JSON. This provides exchange of data between persons liable and the Financial Administration, which does not depend on technology.*

<b>Kratice / Abbreviations</b>	<b>Opis / Description</b>
ISFU	Informacijski sistem finančne uprave / <i>Information system of the financial administration</i>
EOR	Enkratna identifikacijska oznaka računa / <i>Unique identification invoice mark</i>
ZOI	Zaščitna oznaka izdajatelja računa / <i>Protective mark of the invoice issuer</i>
...	

## 2. DIGITALNA POTRDILA (PUBLIC KEY INFRASTRUCTURE) / DIGITAL CERTIFICATES (PUBLIC KEY INFRASTRUCTURE)

Izdajatelj namenskih digitalnih potrdil za namen davčnega potrjevanja računov bo Ministrstvo za javno upravo (v nadaljevanju MJU). V ta namen sta bila v okviru MJU kreirana dva namenska overitelja / *The Ministry of Public Administration (hereinafter MJU) will be the issuer of digital certificates for invoice fiscal verification purposes. For this purpose two certification-service-providers have been created within the MJU:*

- Tax CA Test (uporaba namenskih potrdil v testnem okolju / *usage of certificates for invoice fiscal verification purposes in the test environment*)
- Tax CA (uporaba namenskih potrdil v produkcijskem okolju / *usage of certificates for invoice fiscal verification purposes in the production environment*).

S strani ISFU bodo sprejeta samo sporočila, katera bodo podpisana z zgoraj navedenimi namenskimi digitalnimi potrdili. V produkcijskem okolju ni dovoljeno pošiljanje sporočil podpisanih s testnimi potrdili in obratno. / *Only messages, which will be signed with the above-mentioned digital certificates for invoice fiscal verification purposes, will be accepted by ISFU. In the production environment it is not allowed to send messages signed by test certificates and vice versa.*

Na FURS strani se bodo uporabljali dve digitalni potrdili / *On FURS website two digital certificates will be used:*

- strežniško potrdilo za vzpostavitev TLS seje / *Server certificate for establishing TLS session*
  - o testno okolje / *Test environment:*
    - Izdajatelj / *Issuer: sitest-ca*
    - Nosilec / *Holder: CN = blagajne-test.fu.gov.si*
    - Javni ključ potrdila / *Certificate public key: <http://datoteke.durs.gov.si/dpr/files/test-tls.cer>*
  - o produkcijsko okolje / *Production environment:*
    - Izdajatelj / *Issuer:*
    - Nosilec / *Holder:*
    - Javni ključ potrdila / *Certificate public key:*
- aplikacijsko potrdilo za digitalno podpisovanje sporočil / *application certificate for digital signing of messages*
  - o testno okolje / *test environment:*
    - Izdajatelj / *issuer: CN = Tax CA Test;*
    - Nosilec / *holder: CN = FURS OU = 77695771 OU = DavPotRacTEST*
    - Javni ključ potrdila / *certificate public key: <http://datoteke.durs.gov.si/dpr/files/test-sign.cer>*
  - o produkcijsko okolje / *production environment:*
    - Izdajatelj / *issuer: CN = Tax CA;*
    - Nosilec / *holder: CN = FURS OU = 77695771 OU = DavPotRac*
    - Javni ključ potrdila / *Certificate public key:*

Za vzpostavitev varne seje se uporablja protokol TLS. Omogočena je uporaba TLS protokola verzij 1.0, 1.1 in 1.2. Verziji TLS 1.0 in 1.1 bosta omogočeni do 30.6.2018. Iz varnostnega stališča priporočamo uporabo TLS protokola verzije 1.2 oz. čimprejšnji prehod na to verzijo / *TLS protocol is used for establishing a safe session. It is enabled to use TLS protocol of versions 1.0, 1.1 and 1.2. Versions TLS 1.0 and 1.1 will be enabled until 30.6.2018. From the safety point of view we recommend using TLS protocol of 1.2 version or switching over to this version as soon as possible.*

## 2.2. POSTOPEK PRIDOBIVANJA PRODUKCIJSKIH DIGITALNIH POTRDIL/JAVNIH KLJUČEV / PROCEDURE FOR ACQUIRING PRODUCTION DIGITAL CERTIFICATES/PUBLIC KEYS

Postopek se začne z oddajo vloge za pridobitev digitalnega potrdila v sistemu eDavki (korak 1 v sliki 1). Vlogo lahko odda / *The procedure starts with submitting the digital certificate application in eDavki system (step 1 in Picture 1). The application may be submitted by:*

- zakoniti zastopnik subjekta / *legal representative of the entity,*
- splošni pooblaščenec / *general authorised representative,*
- posebni pooblaščenec / *special authorised representative.*

Vloga se posreduje na MJU (korak 2 v sliki 1), kjer se kreirata referenčna številka in geslo za prevzem digitalnega potrdila. Referenčna številka in geslo se objavita v sistemu eDavki v portalu zavezanca (korak 3 v sliki 1). Zavezanec z vnosom referenčne številke in gesla na portalu MJU (korak 4 v sliki 1), prevzame potrdilo v p12 obliki ((korak 5 v sliki 1). Datoteka je zaščiten z enakim geslom kot je uporabljeno za prevzem. / *The application is submitted to the MJU (step 2 in Picture 1), where the reference number and password for accepting the digital certificate are created. The reference number and password are published in eDavki system in the portal of the person liable (step 3 in Picture 1). The person liable with entry of the reference number and password on MJU portal (step 4 in Picture 1) accepts the certificate in p12 form (step 5 in Picture 1). The file is protected with the same password as it is used for acceptance.*



Slika 1: Pridobivanje namenskih digitalnih potrdil / Picture 1: Acquisition of digital certificates for invoice fiscal verification purposes

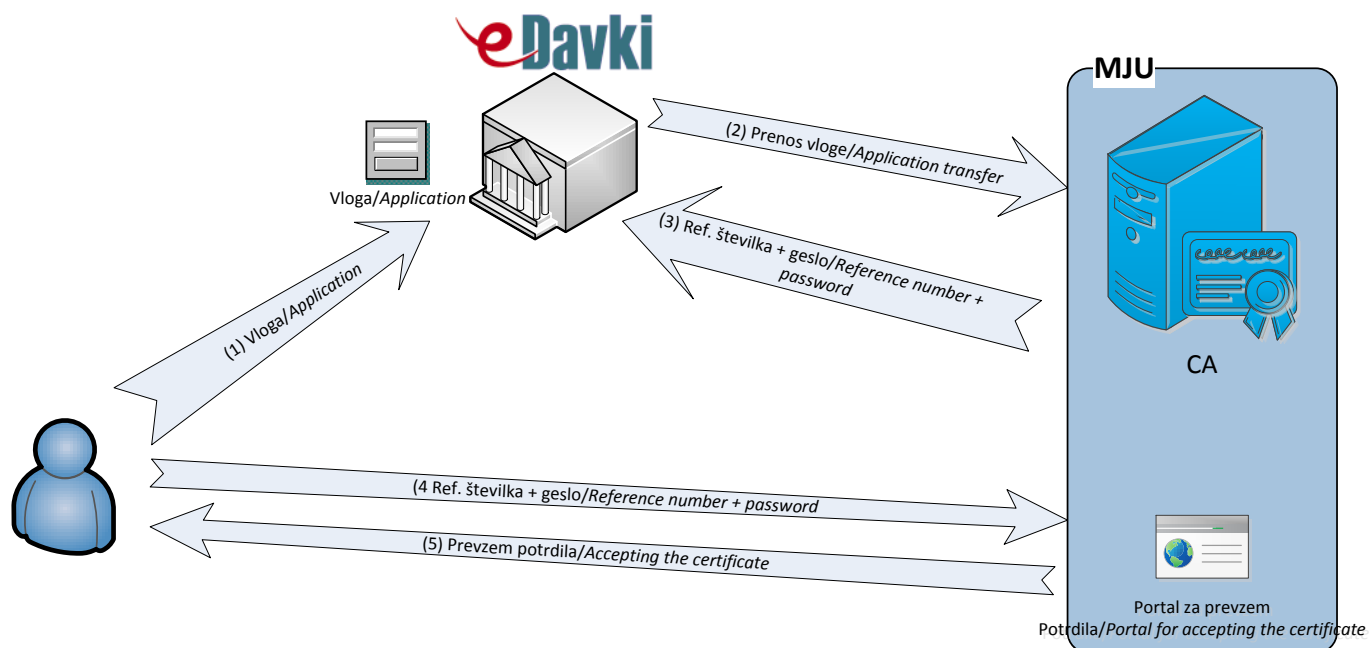

## 2.3. POSTOPEK PREKLICA DIGITALNIH POTRDIL / PROCEDURE FOR WITHDRAWAL OF DIGITAL CERTIFICATES

Postopek se začne z oddajo vloge za preklic v sistemu eDavki (korak 1 v sliki 2). Vlogo za preklic v sistemu eDavki lahko odda / The procedure starts with submitting the application for withdrawal in eDavki system (step 1 in Picture 2). The application for withdrawal in eDavki system may be submitted by:

- zakoniti zastopnik subjekta / legal representative of the entity,
- splošni pooblaščenec / general authorised representative,
- posebni pooblaščenec / special authorised representative.

Vloga se posreduje na MJU, kjer se izvede preklic potrdila in objavi CRL. / The application is submitted to the MJU, where the withdrawal of the certificate is performed and CRL is published.

Slika 2: Preklic namenskih digitalnih potrdil / Picture 2: Withdrawal of digital certificates for invoice fiscal verification purposes

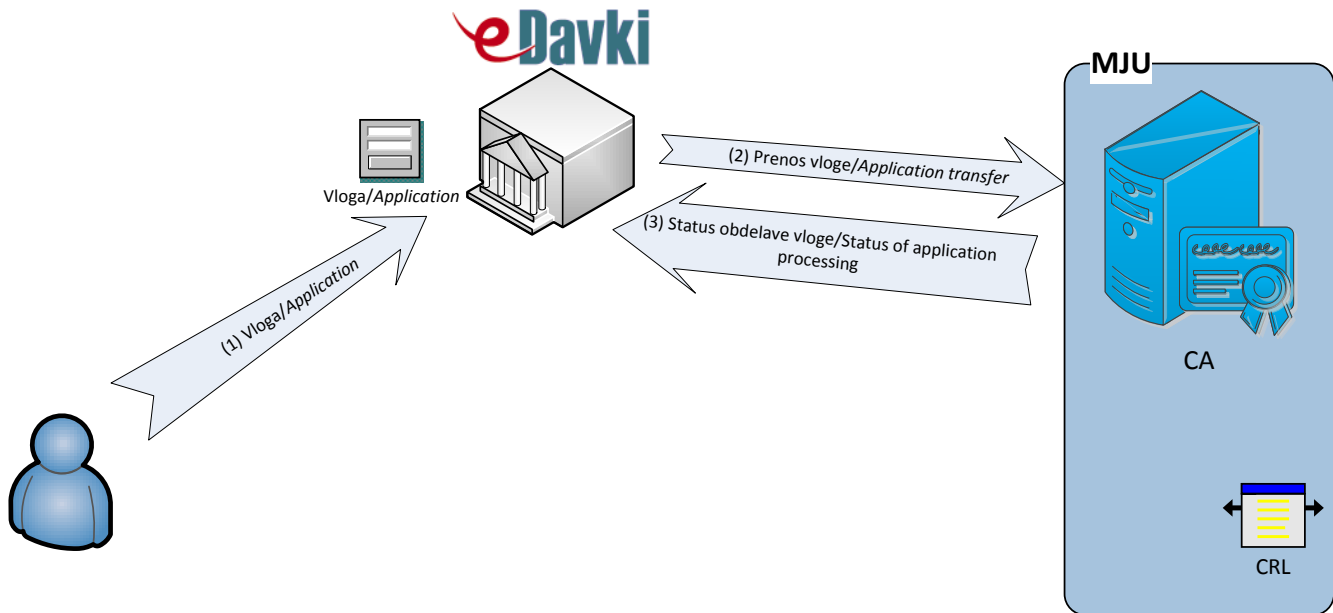

## 2.4 POSTOPEK PRIDOBIVANJA TESTNIH DIGITALNIH POTRDIL / PROCEDURE FOR ACQUIRING TEST DIGITAL CERTIFICATES

Za pridobitev testnega digitalnega potrdila je potrebno poslati elektronsko sporočilo na naslov [dev.blagajne.fu@gov.si](mailto:dev.blagajne.fu@gov.si). V sporočilu navedite naziv podjetja, katero bo razvijalo programsko rešitev za davčno potrjevanje računov in bo uporabljalo zahtevano digitalno potrdilo. Testna digitalna potrdila so izdana na naključno davčno številko in anonimiziran naziv (npr. »Testna oseba n«). / For acquisition of test digital certificates it is necessary to send an electronic message to the following address: [dev.blagajne.fu@gov.si](mailto:dev.blagajne.fu@gov.si). In the message you state the name of the company, which will develop the programme solution for fiscal verification of invoices and which will use the required digital certificate. Test digital certificates are issued on the basis of a random tax number and anonymised name (e.g. »test person n«).

Potrdila bodo dostavljena v obliki datoteke ».p12«. / Certificates will be delivered in the form of ».p12« file.

## 3. VRSTE POSLOVNIH SPOROČIL / TYPES OF BUSINESS MESSAGES

Davčni zavezanci so dolžni poslati na davčni organ Finančne uprave dva tipa sporočil: račun in podatke o poslovnih prostorih. Poleg izmenjave teh poslovnih sporočil lahko preverite delovanje povezave z sporočilom tipa »echo«. Spodaj bodo opisani postopki pošiljanja posameznih sporočil ter podrobnejše vsebine sporočil. / *Taxpayers shall send two types of messages to the Financial Administration: invoice and data about business premises. In addition to exchange of these business messages you can check working of the connection with the message of »echo« type. Below you will find described procedures for sending individual messages and detailed contents of messages.*

### 3.1. RAČUN / INVOICE

Sledeč diagram opisuje proces izdaje računa. / *The following diagram describes the process for issuing invoice.*

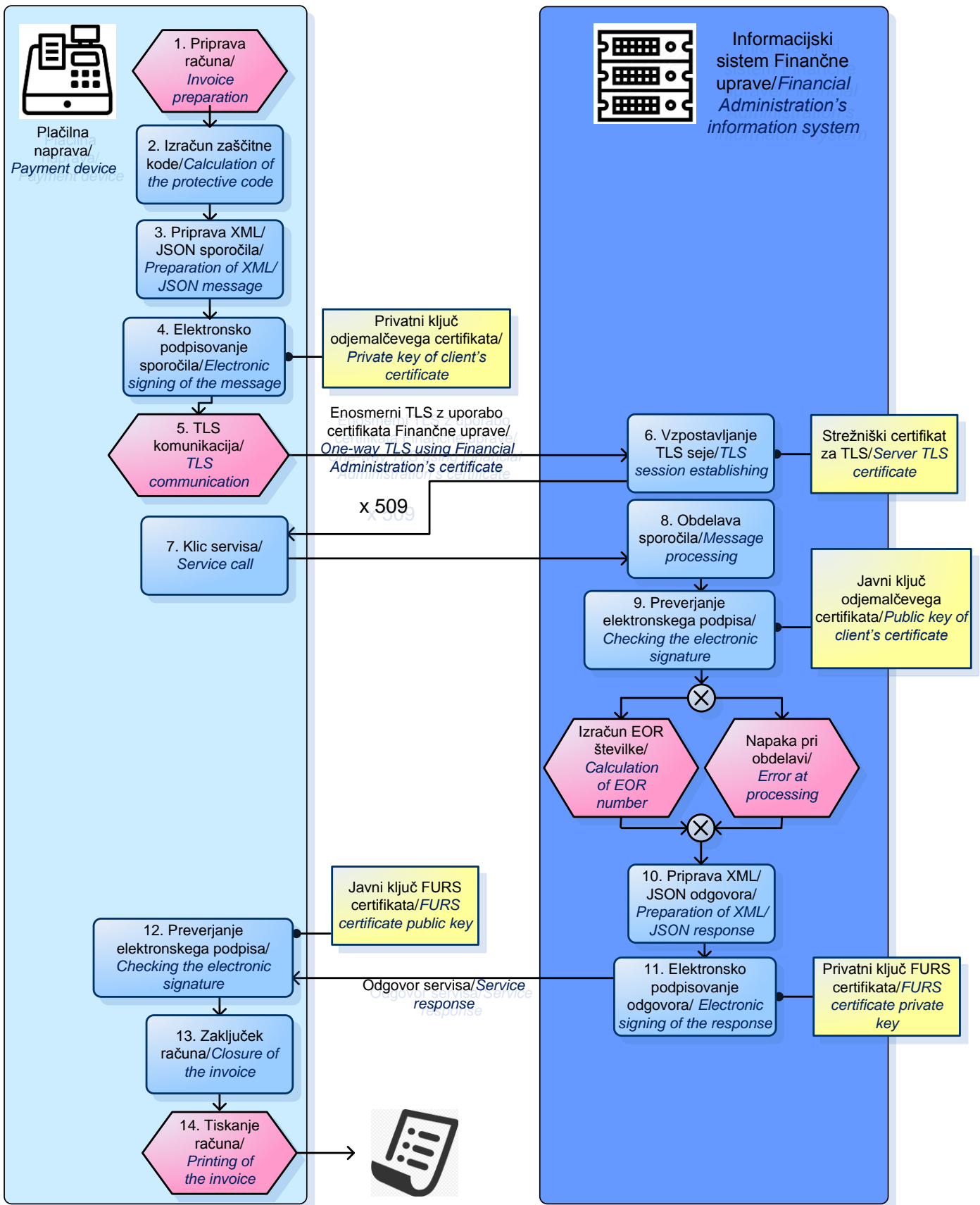

### 3.1.1. VSEBINA IN OBLIKA SPOROČILA TIPA RAČUN / CONTENT AND FORM OF THE MESSAGE OF THE INVOICE TYPE

Spodnja tabela prikazuje nabor podatkov ter njihovo obliko v strukturi računa. / *The table below presents the data set and their form in the invoice structure.*

Indeks / <i>Index</i>	Ime elementa / <i>Name of the element</i>	Uporaba/opis elementa / <i>Usage/description of the element</i>	Obvezen podatek  DA/NE / <i>Obligatory data</i> YES/NO	Tip podatka / <i>Type</i> of data	Zaloga vrednosti / <i>Stock of values</i>	<i>XML element</i>
Glava sporočila / <i>Message header</i>						
R_1.0	+ Identifikator sporočila / <i>Identifier of the message</i>	Enkratni identifikator sporočila. / <i>Unique identifier of the message</i>  Vsako sporočilo mora imeti enkratno identifikacijsko oznako.  Enako velja tudi pri pošiljanju sporočila, ki se zaradi napake pošilja ponovno. / <i>Every message shall have the unique identification mark. The same is obligatory also at sending of the message, which is resent due to an error.</i>	DA / <i>YES</i>	<i>Text</i>	<i>Min36, Max 36</i>	<i>InvoiceRequest /Header/MessagelD</i>
R_2.0	+ Datum in čas pošiljanja / <i>Date and time of sending</i>	Datum in čas pošiljanja sporočila. / <i>Date and time of sending the message</i>  LLLL-MM-DDTUU:MM:SS / <i>YYYY-MM-DDTHH:MM:SS</i>	DA / <i>YES</i>	<i>Date Time</i>		<i>InvoiceRequest /Header/DateTime</i>

Račun / <i>Invoice</i>						
R_3.0	+ Račun – elektronska naprava / <i>Invoice</i> – <i>electronic device</i>	Vpišejo se podatki o računu, ki je izdan z uporabo elektronske naprave. / <i>Data are entered about the invoice, which is issued with usage of the electronic device.</i>	DA, če je račun izdan preko elektronske naprave / <i>YES if the invoice is issued via the electronic device</i>			<i>InvoiceRequest /Invoice</i>
R_3.1	++ Davčna številka zavezanca / <i>Tax number of the person liable</i>	Vpiše se davčna številka zavezanca, ki je izdal račun. / <i>The tax number of the person liable, who has issued the invoice, is entered.</i>	DA / <i>YES</i>	<i>Text</i>	<i>Min8, Max8</i>	<i>InvoiceRequest /Invoice/TaxNu mber</i>
R_3.2	++Datum in čas izdaje računa / <i>Date and time of issuing the invoice</i>	Vpiše se datum in čas izdaje računa, ki je naveden na računu. / <i>Date and time of issuing the invoice, which is stated on the invoice, are entered.</i>  Podatek se vpiše v formatu LLLL-MM- DDTUU:MM:SS. / <i>The data is entered in the following format</i>  <i>YYYY-MM- DDTHH:MM:SS</i>	DA / <i>YES</i>	<i>Date Time</i>		<i>InvoiceRequest /Invoice/IssueD ateTime</i>
R_3.3	++ Način dodelitve številke računa / <i>Method for assigning the invoice</i>	Vpiše se oznaka načina dodeljevanja števil računom / <i>The mark is entered for the method of assigning numbers</i>	DA / <i>YES</i>	<i>Text</i>	<i>Min1, Max1</i>	<i>InvoiceRequest /Invoice/Numbe ringStructure</i>

	<i>number</i>	<p><i>to invoices:</i></p> <p>C – centralno na nivoju poslovnega prostora / <i>centrally at the level of business premises</i></p> <p>B – po posamezni elektronski napravi (blagajna) / <i>per individual electronic device (cash register)</i></p> <p>Oznaka pojasnjuje na kakšen način se računom dodeljujejo številke. / <i>The mark explains the method for assigning numbers to invoices.</i></p> <p>Številke računov se lahko dodeljujejo centralno na nivoju poslovnega prostora ali posamično na elektronski napravi za izdajanje računov. / <i>Invoice numbers may be assigned centrally at the level of business premises or individually on the electronic device for issuing invoices.</i></p>				
R_3.4	++ Številka računa / <i>Number of the invoice</i>	<p>Vpiše se številka izdanega računa. / <i>The number of the issued invoice is entered.</i></p> <p>Vpiše se tudi številka dokumenta, ki spreminja prvotni račun (dobropis,</p>	DA / <i>YES</i>			<i>InvoiceRequest /Invoice/Invoice Identifier</i>

		<p>storno,...) v primeru izvajanja postopka potrjevanja naknadne spremembe podatkov na računu, ki spreminja prvoten račun in se nanj nedvoumno nanaša. / <i>The number of the document is also entered, which changes the original invoice (credit, reversing, etc.) in cases of performing the procedure for verification of subsequent changes of data on the invoice, which changes the original invoice and refers to it with reasonable certainty.</i></p> <p>Številka računa je sestavljena iz treh delov / <i>The invoice number includes three parts:</i></p> <ul style="list-style-type: none"> <li>- Oznaka poslovnega prostora / <i>Mark of business premises</i></li> <li>- Oznaka elektronske naprave za izdajanje računov / <i>Mark of the electronic device for issuing invoices</i></li> <li>- Zaporedna številka računa / <i>Sequence number of the invoice</i></li> </ul>			
--	--	---	--	--	--



		<p>Številka računa se na računu navede v naslednji obliki / <i>The invoice number is stated on the invoice in the following form:</i></p> <p>oznaka poslovnega prostora-oznaka elektronske naprave-zaporedna številka računa / <i>mark of business premises-mark of the electronic device-sequence invoice number</i></p> <p>Primer / <i>Example:</i> TRGOVINA1-BLAG2-1234</p> <p>Podatki se vpisujejo ločeno. / <i>Data are entered separately.</i></p>				
R_3.4.1	+++ Oznaka poslovnega prostora / <i>Mark of business premises</i>	Vsebuje lahko samo črke in številke / <i>It may include only the following letters and numbers: 0-9, a-z, A-Z.</i>	DA / <i>YES</i>	<i>Text</i>	<i>Min1, Max20</i>	<i>InvoiceRequest /Invoice/Invoice Identifier/BusinessPremiseID</i>
R_3.4.2	+++ Oznaka elektronske naprave / <i>Mark of the electronic device</i>	Vsebuje lahko samo črke in številke / <i>It may include only the following letters and numbers: 0-9, a-z, A-Z.</i>	DA / <i>YES</i>	<i>Text</i>	<i>Min1, Max20</i>	<i>InvoiceRequest /Invoice/Invoice Identifier/ElectronicDeviceID</i>
R_3.4.3	+++ Zaporedna	Vsebuje lahko samo številke 0-9.	DA / <i>YES</i>	<i>Text</i>	<i>Min1,</i>	<i>InvoiceRequest /Invoice/Invoice</i>

	številka računa / <i>Sequence number of the invoice</i>	Niso dovoljene vodilne ničle. / <i>It may include only numbers 0-9. Zeros cannot be on the first place.</i>			<i>Max20</i>	<i>Identifier/InvoiceNumber</i>
R_3.5	++ Davčna številka oziroma identifikacijska oznaka za namene DDV kupca / <i>Tax number or identification mark for VAT purposes of the buyer</i>	Vpiše se davčna številka oziroma identifikacijska številka za namene DDV kupca oziroma naročnika v primeru, ko so ti podatki v skladu z davčnimi predpisi navedeni na računu.  Podatek se vpiše, če je naveden na računu. / <i>The tax number is entered or identification number for VAT purposes of the buyer or ordering party in cases when these data are stated on the invoice in accordance with tax regulations.</i>	DA, če so podatki navedeni na računu / <i>YES if data are stated on the invoice</i>	<i>Text</i>	<i>Min1, Max20</i>	<i>InvoiceRequest/Invoice/CustomerVATNumber</i>
R_3.6	++ Vrednost računa / <i>Value of the invoice</i>	Vnese se skupni znesek računa. Vpiše se znesek računa skupaj z DDV in ostalimi davki/dajatvami, zmanjšan za zneske popustov. / <i>The total amount of the invoice is entered. The amount of the invoice is entered together with VAT and other taxes/duties, decreased for amounts of</i>	DA / <i>YES</i>	<i>Decimal Number</i>	Številka / <i>Numbers: max 14</i>  Decimali / <i>Decimals: max 2</i>	<i>InvoiceRequest/Invoice/InvoiceAmount</i>

		<p><i>discounts.</i></p> <p>Decimalno ločilo je pika. / <i>The decimal separator is a dot.</i></p>				
R_3.7	<p>++ Znesek povračil / <i>Amount of refunds</i></p>	<p>Vpiše se znesek povračil na računu, ki se priznajo kupcu (npr. na podlagi dobropisa za vračilo embalaže). / <i>The amount of refunds on the invoice, which are recognized to the buyer (e.g. on the basis of credit for returning packaging), is entered.</i></p> <p>Podatek se vpiše le, če na računu obstajajo povračila. / <i>The data is entered only if there are refunds on the invoice.</i></p> <p>Decimalno ločilo je pika. / <i>The decimal separator is a dot.</i></p>	<p>DA, če obstajajo povračila / <i>YES if there are refunds</i></p>	<p><i>Decimal Number</i></p>	<p>Številka / <i>Numbers: max 14</i></p> <p>Decimala / <i>Decimals: max 2</i></p>	<p><i>InvoiceRequest /Invoice/ReturnsAmount</i></p>
R_3.8	<p>++ Vrednost za plačilo / <i>Value for payment</i></p>	<p>Vpiše se znesek računa za plačilo. / <i>The amount of the invoice for payment is entered.</i></p> <p>Decimalno ločilo je pika. / <i>The decimal separator is a dot.</i></p>	<p>DA / <i>YES</i></p>	<p><i>Decimal Number</i></p>	<p>Številka / <i>Numbers: max 14</i></p> <p>Decimala / <i>Decimals: max 2</i></p>	<p><i>InvoiceRequest /Invoice/PaymentAmount</i></p>
R_3.9	<p>++ Vrednost osnove po davkih in dajatvah, po davčnih zavezancih / <i>Value of the base</i></p>	<p>Vpiše se vrednost osnov po vrsti davka ali dajatve, razdeljeno po davčnih stopnjah, in pripadajoči davek ali dajatev, vrednost dobav na</p>	<p>DA / <i>YES</i></p>			<p><i>InvoiceRequest /Invoice/TaxesP erSeller</i></p>

	<i>according to taxes and duties, according to taxpayers</i>	podlagi posebnih ureditev, dobav pri katerih je plačnik DDV kupec blaga ali naročnik storitve, oproščenih dobav in neobdavčljivih dobav, ločeno po davčnih številkah davčnih zavezancev. / <i>The value is entered for bases according to types of taxes or duties, separated per tax rates, and associated taxes or duties, value of supplies on the basis of special arrangements, supplies where the payer of VAT is the buyer of goods or party ordering services, exempt supplies and non-taxable supplies, separated according to tax numbers of taxpayers.</i>				
R_3.9.1	+++ Davčna številka davčnega zavezanca / <i>Tax number of the taxpayer</i>	Vpiše se davčna številka davčnega zavezanca, v imenu in za račun katerega je bil izdan račun, če je račun izdan v tujem imenu in za tuj račun oziroma če je račun izdal prejemnik računa v imenu in za račun dobavitelja. Če račun ni bil izdan v tujem imenu in za tuj račun, se podatek ne vpisuje. / <i>The tax number of the taxpayer is entered in the</i>	DA, če je račun izdan v tujem imenu in za tuj račun / <i>YES if the invoice has been issued in the name of and on behalf of another person</i>	<i>Text</i>	<i>Min8, Max8</i>	<i>InvoiceRequest /Invoice/TaxesPerSeller/SellerTaxNumber</i>

		<p><i>name of and on behalf of whose the invoice has been issued, if the invoice has been issued in the name of and on behalf of another person or if the invoice has been issued by the recipient of the invoice in the name of and on behalf of the supplier. If the invoice has not been issued in the name of and on behalf of another person, the data is not entered.</i></p>				
R_3.9.2	+++ DDV / VAT	<p>Vpišejo se podatki o DDV. / <i>Data about VAT are entered.</i></p> <p>Podatek se posreduje le, če račun vsebuje znesek obračunanega DDV. / <i>The data is submitted only if the invoice includes the amount of VAT settled.</i></p> <p>Podatek je sestavljen iz davčne stopnje, davčne osnove in zneska davka. / <i>The data consists of the tax rate, tax base and amount of tax.</i></p> <p>Za davčne stopnje lahko obstaja seznam davčnih stopenj pri davčnem organu. / <i>The tax authority may have a list of</i></p>	DA, če obstaja davek / <i>YES if there is tax</i>			<i>InvoiceRequest /Invoice/TaxesPerSeller/VAT</i>

		<i>tax rates.</i>				
R_3.9.21	++++ Davčna stopnja / <i>Tax rate</i>	Vrednost davčne stopnje. / <i>Value of the tax rate</i>  Decimalno ločilo je pika. / <i>The decimal separator is a dot.</i>	DA, če obstaja davek / <i>YES if there is tax</i>	<i>Decimal Number</i>	Številka / <i>Numbers: max 5</i>  Decimali / <i>Decimals: max 2</i>	<i>InvoiceRequest /Invoice/TaxesPerSeller/VAT/TaxRate</i>
R_3.9.22	++++ Davčna osnova / <i>Tax base</i>	Znesek davčne osnove (po zmanjšanju za popuste). / <i>Amount of the tax base (after reduction for discounts)</i>  Decimalno ločilo je pika. / <i>The decimal separator is a dot.</i>	DA, če obstaja davek / <i>YES if there is tax</i>	<i>Decimal Number</i>	Številka / <i>Numbers: max 14</i>  Decimali / <i>Decimals: max 2</i>	<i>InvoiceRequest /Invoice/TaxesPerSeller/VAT/TaxableAmount</i>
R_3.9.23	++++ Davek / <i>Tax</i>	Znesek davka. / <i>Amount of tax</i>  Decimalno ločilo je pika. / <i>The decimal separator is a dot.</i>	DA, če obstaja davek / <i>YES if there is tax</i>	<i>Decimal Number</i>	Številka / <i>Numbers: max 14</i>  Decimali / <i>Decimals: max 2</i>	<i>InvoiceRequest /Invoice/TaxesPerSeller/VAT/TaxAmount</i>
R_3.9.3	+++ Pavšalno nadomestilo / <i>Flat-rate compensation</i>	Vpišejo se podatki o pavšalnem nadomestilu. / <i>Data about the flat-rate compensation are entered.</i>  Podatek se posreduje le, če račun vsebuje znesek obračunanega pavšalnega nadomestila. / <i>The data is submitted only if the invoice includes the amount of the flat-rate compensation settled.</i>  Podatek je sestavljen iz stopnje, osnove in	DA, če obstaja pavšalno nadomestilo / <i>YES if there is flat-rate compensation</i>			<i>InvoiceRequest /Invoice/TaxesPerSeller/FlatRateCompensation</i>

		zneska pavšalnega nadomestila. / <i>The data consists of the rate, base and amount of the flat-rate compensation.</i>				
R_3.9.31	++++ Stopnja pavšalnega nadomestila / <i>Rate of the flat-rate compensation</i>	Vrednost stopnje pavšalnega nadomestila. / <i>Value of the flat-rate compensation's rate</i>  Decimalno ločilo je pika. / <i>The decimal separator is a dot.</i>	DA, če obstaja pavšalno nadomestilo / <i>YES if there is flat-rate compensation</i>	<i>Decimal Number</i>	Številka / <i>Numbers:</i> max 5  Decimali / <i>Decimals:</i> max 2	<i>InvoiceRequest/Invoice/TaxesPerSeller/FlatRateCompensation/FlatRateRate</i>
R_3.9.32	++++ Osnova za obračun pavšalnega nadomestila / <i>Base for settlement of the flat-rate compensation</i>	Osnova oziroma vrednost od katere se obračuna znesek pavšalnega nadomestila (po zmanjšanju za popuste). / <i>The base or value from which the amount of the flat-rate compensation is settled (after reduction for discounts).</i>  Decimalno ločilo je pika. / <i>The decimal separator is a dot.</i>	DA, če obstaja pavšalno nadomestilo / <i>YES if there is flat-rate compensation</i>	<i>Decimal Number</i>	Številka / <i>Numbers:</i> max 14  Decimali / <i>Decimals:</i> max 2	<i>InvoiceRequest/Invoice/TaxesPerSeller/FlatRateCompensation/FlatRateTaxableAmount</i>
R_3.9.33	++++ Znesek pavšalnega nadomestila / <i>Amount of the flat-rate compensation</i>	Znesek pavšalnega nadomestila. / <i>Amount of the flat-rate compensation</i>  Decimalno ločilo je pika. / <i>The decimal separator is a dot.</i>	DA, če obstaja pavšalno nadomestilo / <i>YES if there is flat-rate compensation</i>	<i>Decimal Number</i>	Številka / <i>Numbers:</i> max 14  Decimali / <i>Decimals:</i> max 2	<i>InvoiceRequest/Invoice/TaxesPerSeller/FlatRateCompensation/FlatRateAmount</i>
R_3.9.4	+++ Ostali davki/dajatve / <i>Other</i>	Vpiše se skupni znesek ostalih davkov oziroma dajatev (razen	DA, če obstaja davek/dajatev / <i>YES if there is a</i>	<i>Decimal Number</i>	Številka / <i>Numbers:</i> max 14	<i>InvoiceRequest/Invoice/TaxesPerSeller/OtherT</i>

	<i>taxes/duties</i>	<p>DDV), ki so na računu. / <i>The total amount is entered of other taxes or duties (except VAT), which are on the invoice.</i></p> <p>Podatek se vpisuje le, če račun vsebuje davke oziroma dajatve, ki niso DDV. / <i>The data is entered only if the invoice includes taxes or duties, which are not VAT.</i></p> <p>Decimalno ločilo je pika. / <i>The decimal separator is a dot.</i></p>	<i>tax/duty</i>	<i>ber</i>	<p>Decimalk / <i>Decimals: max 2</i></p>	<i>axesAmount</i>
R_3.9.5	<i>+++ Vrednost oproščenih dobav / Value of exempt supplies</i>	<p>Skupna vrednost dobav blaga ali storitev na računu, ki so v skladu z Zakonom o davku na dodano vrednost oproščene plačila DDV (po zmanjšanju za popuste). / <i>The total value of supplies of goods or services on the invoice, which are in accordance with the Value Added Tax Act exempt from VAT payment (after reduction for discounts).</i></p> <p>Podatek se vpiše le, če na računu obstaja znesek oproščenih dobav. / <i>The data is entered only if the amount of exempt supplies exists on the invoice.</i></p> <p>Decimalno ločilo je</p>	<p>DA, če obstajajo takšne dobave / <i>YES if there are such supplies</i></p>	<i>Decimal Number</i>	<p>Številka / <i>Numbers: max 14</i></p> <p>Decimalk / <i>Decimals: max 2</i></p>	<i>InvoiceRequest /Invoice/TaxesPerSeller/Exempt VATTaxableAmount</i>



		pika. / <i>The decimal separator is a dot.</i>				
R_3.9.6	+++ Vrednost dobav po 76.a členu Zakona o davku na dodano vrednost / <i>Value of supplies on the basis of Article 76.a of the Value Added Tax Act</i>	Vrednost dobav, za katere je v skladu s 76.a členom Zakona o davku na dodano vrednost prejemnik blaga ali storitev plačnik DDV - obrnjena davčna obveznost (po zmanjšanju za popuste). / <i>The value of supplies, for which in accordance with Article 76.a of the Value Added Tax Act the recipient of goods or services is the payer of VAT – reverse charge procedure (after reduction for discounts).</i>  Podatek se vpiše le, če na računu obstajajo takšne dobave. / <i>The data is entered only if such supplies exist on the invoice.</i>  Decimalno ločilo je pika. / <i>The decimal separator is a dot.</i>	DA, če obstajajo takšne dobave / <i>YES if there are such supplies</i>	<i>Decimal Number</i>	Številka / <i>Numbers:</i> max 14  Decimalna / <i>Decimals:</i> max 2	<i>InvoiceRequest / Invoice/TaxesPerSeller/ReverseVATTaxableAmount</i>
R_3.9.7	+++ Vrednost neobdavčljivih dobav / <i>Value of non-taxable supplies</i>	Vrednost neobdavčljivih dobav blaga ali storitev na računu (po zmanjšanju za popuste). Podatek se vpiše le, če na računu obstaja vrednost dobav, ki v skladu z Zakonom o davku na dodano vrednost niso predmet DDV. /	DA, če obstajajo takšne dobave / <i>YES if there are such supplies</i>	<i>Decimal Number</i>	Številka / <i>Numbers:</i> max 14  Decimalna / <i>Decimals:</i> max 2	<i>InvoiceRequest / Invoice/TaxesPerSeller/NontaxableAmount</i>

		<p><i>The value of non-taxable supplies of goods or services on the invoice (after reduction for discounts). The data is entered only if the value of supplies, which are not subject to VAT in accordance with the Value Added Tax Act, exists on the invoice.</i></p> <p>Decimalno ločilo je pika. / <i>The decimal separator is a dot.</i></p>				
R_3.9.8	+++ Vrednost dobav, ki se nanaša na posebne ureditve / <i>Value of supplies, which refers to special arrangements</i>	<p>Vrednost dobav, za katere se uporablja posebna ureditev, po kateri se obdavčuje razlika v ceni, in sicer posebna ureditev za rabljeno blago, umetniške predmete, zbirke in starine (101. člen Zakona o davku na dodano vrednost). Vpiše se tudi vrednost dobav, za katere se obračunava in plačuje DDV po posebni ureditvi za potovalne agencije (97. člen Zakona o davku na dodano vrednost). Vpiše se znesek, ki je zmanjšan za popuste. / <i>The value of supplies, for which a special arrangement is used, on the basis of which the margin is taxed, i.e. the special arrangement for second-hand</i></p>	DA, če obstajajo takšne dobave / <i>YES if there are such supplies</i>	<i>Decimal Number</i>	Številka / <i>Numbers:</i> max 14 Decimalna / <i>Decimals:</i> max 2	<i>InvoiceRequest / Invoice/TaxesPerSeller/Special TaxRulesAmount</i>

		<p>goods, works of art, collector's items and antiques (Article 101 of the Value Added Tax Act). The value of supplies is also entered, for which VAT is charged and paid according to the special arrangement for travel agencies (Article 97 of the Value Added Tax Act). The amount is entered, which is reduced for discounts.</p> <p>Decimalno ločilo je pika. / <i>The decimal separator is a dot.</i></p>				
R_3.10	<p>++ Davčna številka osebe (operaterja) na elektronski napravi / <i>Tax number of the person (operator) at the electronic device</i></p>	<p>Vpiše še davčna številka fizične osebe (operaterja), ki izda račun z uporabo elektronske naprave za izdajanje računov.</p> <p>V primeru izdaje računa preko samopostrežnih elektronskih naprav oziroma ko se račun izda brez prisotnosti fizične osebe, se vpiše davčna številka zavezanca. / <i>The tax number is entered of the individual (operator), who issues the invoice with the usage of the electronic device for issuing invoices. In cases of issuing invoices via self-service electronic devices</i></p>	<p>DA, če ima oseba slovensko davčno številko / <i>YES if the person has a Slovene tax number</i></p>	<i>Text</i>	<i>Min8, Max8</i>	<i>InvoiceRequest /Invoice/Operat orTaxNumber</i>

		<p><i>or when invoices are issued without the presence of individuals, the tax number of the person liable is entered.</i></p> <p>Če oseba nima slovenske davčne številke, se podatek ne vpisuje. / <i>The data is not entered if the person has no Slovene tax number.</i></p>				
R_3.11	++ Oseba (operater) na elektronski napravi nima slovenske davčne številke / <i>The person (operator) at the electronic device has no Slovene tax number</i>	Vpiše se <i>true</i> , če fizična oseba (operater), ki izda račun z uporabo elektronske naprave, nima slovenske davčne številke, drugače <i>false</i> (1 - true, 0 - false). / <i>You enter »true« if the individual (operator), who issues the invoice with the usage of the electronic device, has no Slovene tax number, otherwise »false« (1 - true, 0 - false).</i>	DA, če oseba nima slovenske davčne številke / <i>YES if the person has no Slovene tax number</i>	<i>Boolean</i>		<i>InvoiceRequest /Invoice/Foreign Operator</i>
R_3.12	++ Zaščitna oznaka izdajatelja računa / <i>Protective mark of the invoice issuer</i>	Vpiše se zaščitna oznaka izdajatelja računa. / <i>The protective mark of the invoice issuer is entered.</i>  Zaščitna oznaka je sestavljena iz 32 znakov v heksadecimalnem formatu. / <i>The protective mark</i>	DA / <i>YES</i>	<i>Text</i>	<i>Min32, Max32</i>	<i>InvoiceRequest /Invoice/Protect edID</i>

		<p><i>includes 32 characters in the hexadecimal notation.</i></p> <p>Primer / <i>Example:</i> 8202f0f963e37a22 58b034cf8ae7bbc1</p>				
R_3.13	<p><b>++</b> Oznaka naknadnega posredovanja računa / <i>Mark of the subsequent submitting of the invoice</i></p>	<p>Naknadno posredovani račun je račun, ki je bil izdan brez enkratne identifikacijske oznake računa – EOR (npr. zaradi prekinitve elektronske povezave z davčnim organom).</p> <p>Vpiše se <i>true</i>, če je račun naknadno posredovan davčnemu organu, drugače <i>false</i> (1 – true, 0 – false). / <i>Subsequently submitted invoices are invoices, which have been issued without the unique identification invoice mark – EOR (e.g. due to disconnections of electronic connections with the tax authority). If the invoice is subsequently submitted to the tax authority, »true« is entered, otherwise »false« (1 – true, 0 – false).</i></p>	<p>DA, če se račun posreduje naknadno / <i>YES if the invoice is submitted subsequently</i></p>	<i>Boolean</i>		<i>InvoiceRequest /Invoice/SubsequentSubmit</i>
R_3.14	<p><b>++</b> Številka računa, ki se spreminja / <i>Number of the invoice,</i></p>	<p>Vpiše se številka prvotnega računa v primeru naknadne spremembe podatkov na</p>	<p>DA, če se spreminja prvoten račun, ki je bil izdan preko elektronske naprave / <i>YES if</i></p>			<i>InvoiceRequest /Invoice/ReferenceInvoiceIdentifier</i>

	<p><i>which is changed</i></p>	<p>prvotnem računu, če je bil prvoten račun izdan preko elektronske naprave. / <i>The number of the original invoice is entered in cases of subsequent changes of data on the original invoice if the original invoice has been issued via the electronic device.</i></p> <p>Zavezanec izvaja postopek potrjevanja računov tudi za vse naknadne spremembe podatkov na računu, ki spreminjajo prvoten račun in se nanj nedvoumno nanašajo. / <i>The person liable conducts the procedure for verification of invoices also for all subsequent changes of data on the invoice, which change the original invoice and they refer to it with reasonable certainty.</i></p> <p>Podatek se vpiše v primeru, če se z računom, izdanim preko elektronske naprave, spreminja prvoten račun, ki je bil izdan preko elektronske naprave. / <i>The data is entered in cases if the original</i></p>	<p><i>the original invoice is changed, which has been issued via the electronic device</i></p>			
--	--------------------------------	---	--	--	--	--

		<p><i>invoice, which has been issued via the electronic device, changes with the invoice, issued via the electronic device.</i></p> <p>Za vpis številke računa, ki se spreminja, veljajo enaka pravila kot pri vpisu številke računa. Številka računa je sestavljena iz treh delov / <i>Rules for entry of the invoice number, which is changed, are the same as those for entry of the invoice number. The invoice number includes three parts:</i></p> <ul style="list-style-type: none"> <li>- Oznaka poslovnega prostora / <i>Mark of business premises</i></li> <li>- Oznaka elektronske naprave za izdajanje računov / <i>Mark of the electronic device for issuing invoices</i></li> <li>- Zaporedna številka računa / <i>Sequence number of the invoice</i></li> </ul> <p>Številka računa se na računu navede v naslednji obliki / <i>The invoice number is stated on the invoice in the</i></p>				
--	--	--	--	--	--	--

		<p><i>following form:</i></p> <p>oznaka poslovnega prostora-oznaka elektronske naprave-zaporedna številka računa / <i>mark of business premises-mark of the electronic device- sequence invoice number</i></p> <p>Primer / <i>Example:</i> TRGOVINA1-BLAG2-1234</p> <p>Podatki se vpisujejo ločeno. / <i>Data are entered separately.</i></p>				
R_3.14.1	+++ Oznaka poslovnega prostora / <i>Mark of business premises</i>	Vsebuje lahko samo črke in številke / <i>It may include only the following letters and numbers: 0-9, a-z, A-Z.</i>	DA, če se spreminja prvoten račun, ki je bil izdan preko elektronske naprave / <i>YES if the original invoice is changed, which has been issued via the electronic device</i>	<i>Text</i>	<i>Min1, Max20</i>	<i>InvoiceRequest/Invoice/ReferenceInvoice/ReferenceInvoiceIdentifier/BusinessPremiseID</i>
R_3.14.2	+++ Oznaka elektronske naprave / <i>Mark of the electronic device</i>	Vsebuje lahko samo črke in številke / <i>It may include only the following letters and numbers: 0-9, a-z, A-Z.</i>	DA, če se spreminja prvoten račun, ki je bil izdan preko elektronske naprave / <i>YES if the original invoice is changed, which has been issued via the electronic device</i>	<i>Text</i>	<i>Min1, Max20</i>	<i>InvoiceRequest/Invoice/ReferenceInvoice/ReferenceInvoiceIdentifier/ElectronicDeviceID</i>
R_3.14.3	+++ Zaporedna številka računa / <i>Sequence number of the</i>	Vsebuje lahko samo številke 0-9. Niso dovoljene vodilne ničle. / <i>It may include only numbers 0-9. Zeros cannot be on the</i>	DA, če se spreminja prvoten račun, ki je bil izdan preko elektronske naprave / <i>YES if the original invoice is changed, which</i>	<i>Text</i>	<i>Min1, Max20</i>	<i>InvoiceRequest/Invoice/ReferenceInvoice/ReferenceInvoiceIdentifier/InvoiceNumber</i>



	<i>invoice</i>	<i>first place.</i>	<i>has been issued via the electronic device</i>			
R_3.15	<p>++ Datum in čas izdaje računa, ki se spreminja / <i>Date and time of issuing the invoice, which is changed</i></p>	<p>Vpiše se datum in čas izdaje prvotnega računa v primeru naknadne spremembe podatkov na prvotnem računu, če je bil prvoten račun izdan preko elektronske naprave. / <i>Date and time are entered of issuing the original invoice in cases of subsequent changes of data on the original invoice if the original invoice has been issued via the electronic device.</i></p> <p>Podatek se vpiše v primeru, če se z računom, izdanim preko elektronske naprave, spreminja prvoten račun, ki je bil izdan preko elektronske naprave. / <i>The data is entered in cases if the original invoice, which has been issued via the electronic device, is changed with the invoice, issued via the electronic device.</i></p> <p>Podatek se vpiše v formatu LLLL-MM-DDTUU:MM:SS. / <i>The data is entered in the following format</i></p>	NE / NO	<i>Date Time</i>		<i>InvoiceRequest /Invoice/ReferenceInvoice/ReferenceInvoicelsueDateTime</i>

		YYYY-MM-DDTHH:MM:SS				
R_3.16	++ Številka računa iz vezane knjige računov, ki se spreminja / <i>Number of the invoice from the pre-numbered invoice book, which is changed</i>	Vpiše se številka izdanega računa iz vezane knjige računov, ki se spreminja, če je bil prvoten račun izdan iz vezane knjige računov. / <i>The number is entered of the issued invoice from the pre-numbered invoice book, which is changed, if the original invoice has been issued from the pre-numbered invoice book.</i>  Podatek se vpiše v primeru, če se z računom, izdanim preko elektronske naprave, spreminja prvoten račun, ki je bil izdan iz vezane knjige računov. / <i>The data is entered in cases when the original invoice is changed, which has been issued from the pre-numbered invoice book, with the invoice, issued via the electronic device.</i>	DA, če se spreminja prvoten račun iz vezane knjige računov / <i>YES if the original invoice from the pre-numbered invoice book is changed</i>	<i>Text</i>	<i>Min1, Max20</i>	<i>InvoiceRequest /Invoice/ReferenceSalesBook/ReferenceSalesBookIdentifier/InvoiceNumber</i>
R_3.17	++ Številka seta računa iz vezane knjige računov, ki se spreminja / <i>Number of the invoice set (original</i>	Vpiše se številka posameznega obrazca računa (seta) izdanega iz vezane knjige računov, ki se spreminja, če je bil prvoten račun izdan	DA, če se spreminja prvoten račun iz vezane knjige računov / <i>YES if the original invoice from the pre-numbered invoice book is</i>	<i>Text</i>	<i>Min2, Max2</i>	<i>InvoiceRequest /Invoice/ReferenceSalesBook/ReferenceSalesBookIdentifier/SetNumber</i>

	<i>invoice + its two copies) from the pre-numbered invoice book, which is changed</i>	<p>iz vezane knjige računov / <i>The number is entered of an individual invoice form (set) issued from the pre-numbered invoice book, which is changed if the original invoice has been issued from the pre-numbered invoice book.</i></p> <p>Podatek se vpiše v primeru, če se z računom, izdanim preko elektronske naprave, spreminja prvoten račun, ki je bil izdan iz vezane knjige računov. / <i>The data is entered in cases when the original invoice, which has been issued from the pre-numbered invoice book, is changed with the invoice, issued via the electronic device.</i></p>	<i>changed</i>			
R_3.18	<b>++</b> Serijska številka vezane knjige računov iz katere je bil izdan račun, ki se spreminja / <i>Serial number of the pre-invoice book, from which the invoice, which is changed, has been issued</i>	Vpiše se serijska številka vezane knjige računov iz katere je bil izdan račun, ki se spreminja, če je bil prvoten račun izdan iz vezane knjige računov. / <i>The serial number is entered of the pre-numbered invoice book, from which the invoice, which is changed, has been issued if the original invoice has been issued from the pre-numbered</i>	DA, če se spreminja prvoten račun iz vezane knjige računov / <i>YES if the original invoice is changed from the pre-numbered invoice book</i>	<i>Text</i>	<i>Min12, Max12</i>	<i>InvoiceRequest /Invoice/ReferenceSalesBook/ ReferenceSalesBookIdentifier/SerialNumber</i>

		<p><i>invoice book.</i></p> <p>Podatek se vpiše v primeru, če se z računom, izdanim preko elektronske naprave, spreminja prvoten račun, ki je bil izdan iz vezane knjige računov. / <i>The data is entered in cases when the original invoice, which has been issued from the pre-numbered invoice book, is changed with the invoice, issued via the electronic device.</i></p>				
R_3.19	<p>++ Datum izdaje računa iz vezane knjige računov, ki se spreminja / <i>Date of issuing the invoice from the pre-numbered invoice book, which is changed</i></p>	<p>Vpiše se datum izdaje prvotnega računa iz vezane knjige računov, ki se spreminja, če je bil prvoten račun izdan iz vezane knjige računov. / <i>The issuing date is entered for the original invoice from the pre-numbered invoice book, which is changed if the original invoice has been issued from the pre-numbered invoice book.</i></p> <p>Podatek se vpiše v formatu LLLL-MM-DD. / <i>The data is entered in the following format: YYYY-MM-DD.</i></p> <p>Podatek se vpiše v</p>	NE / NO	<i>Date</i>		<i>InvoiceRequest /Invoice/ReferenceSalesBook/ReferenceSalesBookIssueDate</i>

		primeru, če se z računom, izdanim preko elektronske naprave, spreminja prvoten račun, ki je bil izdan iz vezane knjige računov. / <i>The data is entered in cases when the original invoice, which has been issued from the pre-numbered invoice book, is changed with the invoice, issued via the electronic device.</i>				
R_3.20	++ Ostalo / <i>Other</i>	Vpišejo se morebitne druge oznake, ki podrobneje pojasnjujejo zapise v zvezi z vsebino izdanih računov in njihove spremembe. / <i>Potential other marks are entered, which explain in detail the records in connection with the content of invoices issued and their changes.</i>	NE / <i>NO</i>	<i>Text</i>	<i>Min1, Max1000</i>	<i>InvoiceRequest /Invoice/Special Notes</i>
R_4.0	+ Račun – vezana knjiga računov / <i>Invoice – pre-numbered invoice book</i>	Vpišejo se podatki o računu, ki je izdan iz vezane knjige računov in je naknadno posredovan v potrditev davčnemu organu. / <i>The data are entered about the invoice, which has been issued from the pre-numbered invoice book and it is</i>	DA, če je račun izdan iz vezane knjige računov / <i>YES if the invoice has been issued from the pre-numbered invoice book</i>			<i>InvoiceRequest /SalesBookInvoice</i>

		<i>subsequently submitted to the tax authority for verification.</i>				
R_4.1	++ Davčna številka zavezanca / <i>Tax number of the person liable</i>	Vpiše se davčna številka zavezanca, ki je izdal račun. / <i>The tax number of the person liable, who has issued the invoice, is entered.</i>	DA / YES	Text	Min8, Max8	<i>InvoiceRequest/SalesBookInvoice/TaxNumber</i>
R_4.2	++Datum izdaje računa / <i>Date of issuing the invoice</i>	Vpiše se datum izdaje računa, ki je naveden na računu. / <i>The date of issuing the invoice, which is stated on the invoice, is entered.</i>  Podatek se vpiše v formatu LLLL-MM-DD. / <i>The data is entered in the following format: YYYY-MM-DD.</i>	DA / YES	Date		<i>InvoiceRequest/SalesBookInvoice/IssueDate</i>
R_4.3	++ Številka računa / <i>Number of the invoice</i>	Vpiše se številka računa, izdanega iz vezane knjige računov. / <i>The number of the invoice is entered, issued from the pre-numbered invoice book.</i>  Vpiše se tudi številka dokumenta, ki spreminja prvotni račun (dobropis, storno,...), v primeru izvajanja postopka potrjevanja naknadne spremembe	DA / YES	Text	Min1, Max20	<i>InvoiceRequest/SalesBookInvoice/SalesBookIdentifier/InvoiceNumber</i>

		<p>podatkov na računu, ki spreminja prvoten račun in se nanj nedvoumno nanaša. / <i>The number of the document is also entered, which changes the original invoice (credit, reversing, etc.) in cases of performing the procedure for verification of subsequent changes of data on the invoice, which changes the original invoice and refers to it with reasonable certainty.</i></p>				
R_4.4	++ Številka seta računa iz vezane knjige računov / <i>Number of the invoice set (original invoice + its two copies) from the pre-numbered invoice book</i>	Vpiše se številka obrazca računa (seta) iz vezane knjige računov. / <i>The number is entered of the invoice form (set) from the pre-numbered invoice book.</i>	DA / YES	Text	Min2, Max2	<i>InvoiceRequest/SalesBookInvoice/SalesBookIdentifier/SetNumber</i>
R_4.5	++ Serijska številka vezane knjige računov / <i>Serial number of the pre-numbered invoice book</i>	Vpiše se serijska številka vezane knjige računov iz katere je bil izdan račun. / <i>The serial number is entered of the pre-numbered invoice book, from which the invoice has been issued.</i>	DA / YES	Text	Min12, Max12	<i>InvoiceRequest/SalesBookInvoice/SalesBookIdentifier/SerialNumber</i>
R_4.6	++ Oznaka poslovnega prostora /	Vpiše se oznaka poslovnega prostora v katerem	DA / YES	Text	Min1, Max20	<i>InvoiceRequest/SalesBookInvoice/BusinessPr</i>

	<i>Mark of business premises</i>	<p>je bil izdan račun iz vezane knjige računov. / <i>The mark of business premises is entered, in which the invoice has been issued from the pre-numbered invoice book.</i></p> <p>Oznaka poslovnega prostora mora biti enaka oznaki, ki je bila posredovana v okviru podatkov o poslovnih prostorih. / <i>The mark of business premises shall be the same as the mark, which has been submitted within data about business premises.</i></p> <p>Vsebuje lahko samo črke in številke / <i>It may include only the following letters and numbers: 0-9, a-z, A-Z.</i></p>				<i>emiseID</i>
R_4.7	<i>++ Davčna številka oziroma identifikacijska oznaka za namene DDV kupca / Tax number or identification mark for VAT purposes of the buyer</i>	<p>Vpiše se davčna številka oziroma identifikacijska številka za namene DDV kupca oziroma naročnika v primeru, ko so ti podatki v skladu z davčnimi predpisi navedeni na računu.</p> <p>Podatek se vpiše, če je naveden na računu. / <i>The tax number is entered or identification number for VAT</i></p>	DA, če so podatki navedeni na računu / <i>YES if data are stated on the invoice</i>	<i>Text</i>	<i>Min1, Max20</i>	<i>InvoiceRequest /SalesBookInvoice/CustomerVATNumber</i>



		<p><i>purposes of the buyer or ordering party in cases when these data are in accordance with tax regulations stated on the invoice.</i></p> <p><i>The data is entered if it is stated on the invoice.</i></p>				
R_4.8	<p>++ Vrednost računa / <i>Value of the invoice</i></p>	<p>Vnese se skupni znesek računa. Vpiše se znesek računa skupaj z DDV in ostalimi davki/dajatvami, zmanjšan za zneske popustov. / <i>The total amount of the invoice is entered. The amount of the invoice is entered together with VAT and other taxes/duties, decreased for amounts of discounts.</i></p> <p>Decimalno ločilo je pika. / <i>The decimal separator is a dot.</i></p>	DA / <i>YES</i>	<i>Decimal Number</i>	<p>Številka / <i>Numbers: max 14</i></p> <p>Decimalna / <i>Decimals: max 2</i></p>	<i>InvoiceRequest /SalesBookInvoice/InvoiceAmount</i>
R_4.9	<p>++ Znesek povračil / <i>Amount of refunds</i></p>	<p>Vpiše se znesek povračil na računu, ki se priznajo kupcu (npr. na podlagi dobropisa za vračilo embalaže). / <i>The amount of refunds on the invoice is entered, which are recognized to the buyer (e.g. on the credit basis for returning packaging).</i></p> <p>Podatek se vpiše</p>	DA, če obstajajo povračila / <i>YES if there are refunds</i>	<i>Decimal Number</i>	<p>Številka / <i>Numbers: max 14</i></p> <p>Decimalna / <i>Decimals: max 2</i></p>	<i>InvoiceRequest /SalesBookInvoice/ReturnsAmount</i>

		<p>le, če na računu obstajajo povračila. / <i>The data is entered only if there are refunds on the invoice.</i></p> <p>Decimalno ločilo je pika. / <i>The decimal separator is a dot.</i></p>				
R_4.10	++ Vrednost za plačilo / <i>Value for payment</i>	<p>Vpiše se znesek računa za plačilo. / <i>The invoice amount for payment is entered.</i></p> <p>Decimalno ločilo je pika. / <i>The decimal separator is a dot.</i></p>	DA / <i>YES</i>	<i>Decimal Number</i>	Številka / <i>Numbers:</i> max 14 Decimalna / <i>Decimals:</i> max 2	<i>InvoiceRequest /SalesBookInvoice/PaymentAmount</i>
R_4.11	++ Vrednost osnove po davkih in dajatvah, po davčnih zavezancih / <i>Value of the base according to taxes and duties, according to taxpayers</i>	<p>Vpiše se vrednost osnov po vrsti davka ali dajatve, razdeljeno po davčnih stopnjah, in pripadajoči davek ali dajatev, vrednost dobav na podlagi posebnih ureditev, dobav pri katerih je plačnik DDV kupec blaga ali naročnik storitve, oproščenih dobav in neobdavčljivih dobav, ločeno po davčnih številkah davčnih zavezancev. / <i>The value of bases is entered according to the type of taxes or duties, divided according to tax rates, and associated taxes or duties, value of supplies on the basis of special arrangements, supplies where the payer of VAT is the</i></p>	DA / <i>YES</i>			<i>InvoiceRequest /SalesBookInvoice/TaxesPerSeller</i>

		<i>buyer of goods or party ordering services, exempt supplies and non-taxable supplies, divided according to tax numbers of taxpayers.</i>				
R_4.11.1	+++ Davčna številka davčnega zavezanca / <i>Tax number of the taxpayer</i>	Vpiše se davčna številka davčnega zavezanca, v imenu in za račun katerega je bil izdan račun, če je račun izdan v tujem imenu in za tuj račun oziroma če je račun izdal prejemnik računa v imenu in za račun dobavitelja. Če račun ni bil izdan v tujem imenu in za tuj račun, se podatek ne vpisuje. / <i>The tax number of the taxpayer is entered, in the name of and on behalf of whose the invoice has been issued if the invoice has been issued in the name of and on behalf of another person or if the invoice has been issued by the recipient of the invoice in the name of and on behalf of the supplier. If the invoice has not been issued in the name of and on behalf of another person, the data is not entered.</i>	DA, če je račun izdan v tujem imenu in za tuj račun / <i>YES if the invoice has been issued in the name of and on behalf of another person</i>	<i>Text</i>	<i>Min8, Max8</i>	<i>InvoiceRequest /SalesBookInvoice/TaxesPerSeller/SellerTaxNumber</i>
R_4.11.2	+++ DDV / <i>VAT</i>	Vpišejo se podatki o DDV. / <i>Data about VAT are</i>	DA, če obstaja davek / <i>YES if the</i>			<i>InvoiceRequest /SalesBookInvoice/TaxesPerSe</i>

		<p><i>entered.</i></p> <p>Podatek se posreduje le, če račun vsebuje znesek obračunanega DDV. / <i>The data is submitted only if the invoice includes the amount of the settled VAT.</i></p> <p>Podatek je sestavljen iz davčne stopnje, davčne osnove in zneska davka. / <i>The data includes the tax rate, tax base and amount of tax.</i></p> <p>Za davčne stopnje lahko obstaja seznam davčnih stopenj pri davčnem organu. / <i>The tax authority may have a list of tax rates.</i></p>	<i>tax exists</i>			<i>ller/VAT</i>
R_4.11.21	++++ Davčna stopnja / <i>Tax rate</i>	<p>Vrednost davčne stopnje. / <i>Value of the tax rate</i></p> <p>Decimalno ločilo je pika. / <i>The decimal separator is a dot.</i></p>	DA, če obstaja davek / <i>YES if the tax exists</i>	<i>Decimal Number</i>	Številka / <i>Numbers:</i> max 5 Decimali / <i>Decimals:</i> max 2	<i>InvoiceRequest /SalesBookInvoice/TaxesPerSeller/VAT/TaxRate</i>
R_4.11.22	++++ Davčna osnova / <i>Tax base</i>	<p>Znesek davčne osnove (po zmanjšanju za popuste). / <i>Amount of the tax base (after reduction for discounts)</i></p> <p>Decimalno ločilo je pika. / <i>The decimal separator is a dot.</i></p>	DA, če obstaja davek / <i>YES if the tax exists</i>	<i>Decimal Number</i>	Številka / <i>Numbers:</i> max 14 Decimali / <i>Decimals:</i> max 2	<i>InvoiceRequest /SalesBookInvoice/TaxesPerSeller/VAT/TaxableAmount</i>

R_4.11.23	++++ Davek / <i>Tax</i>	Znesek davka. / <i>Amount of tax</i>  Decimalno ločilo je pika. / <i>The decimal separator is a dot.</i>	DA, če obstaja davek / <i>YES if the tax exists</i>	<i>Decimal Number</i>	Številka / <i>Numbers:</i> max 14  Decimalk / <i>Decimals:</i> max 2	<i>InvoiceRequest /SalesBookInvoice/TaxesPerSeller/VAT/TaxAmount</i>
R_4.11.3	+++ Pavšalno nadomestilo / <i>Flat-rate compensation</i>	Vpišejo se podatki o pavšalnem nadomestilu. / <i>The data about the flat-rate compensation are entered.</i>  Podatek se posreduje le, če račun vsebuje znesek obračunanega pavšalnega nadomestila. / <i>The data is submitted only if the invoice includes the amount of the settled flat-rate compensation.</i>  Podatek je sestavljen iz stopnje, osnove in zneska pavšalnega nadomestila. / <i>The data includes the rate, base and amount of the flat-rate compensation.</i>	DA, če obstaja pavšalno nadomestilo / <i>YES if the flat-rate compensation exists</i>			<i>InvoiceRequest /SalesBookInvoice/TaxesPerSeller/FlatRateCompensation</i>
R_4.11.31	++++ Stopnja pavšalnega nadomestila / <i>Rate of the flat-rate compensation</i>	Vrednost stopnje pavšalnega nadomestila. / <i>The value of the rate for the flat-rate compensation</i>  Decimalno ločilo je pika. / <i>The decimal separator is a dot.</i>	DA, če obstaja pavšalno nadomestilo / <i>YES if the flat-rate compensation exists</i>	<i>Decimal Number</i>	Številka / <i>Numbers:</i> max 5  Decimalk / <i>Decimals:</i> max 2	<i>InvoiceRequest /SalesBookInvoice/TaxesPerSeller/FlatRateCompensation/FlatRateRate</i>

R_4.11.32	++++ Osnova za obračun pavšalnega nadomestila / <i>Base for settlement of the flat-rate compensation</i>	Osnova oziroma vrednost od katere se obračuna znesek pavšalnega nadomestila (po zmanjšanju za popuste). / <i>The base or value from which the amount of the flat-rate compensation is settled (after reduction for discounts).</i>  Decimalno ločilo je pika. / <i>The decimal separator is a dot.</i>	DA, če obstaja pavšalno nadomestilo / <i>YES if the flat-rate compensation exists</i>	<i>Decimal Number</i>	Številka / <i>Numbers:</i> max 14  Decimali / <i>Decimals:</i> max 2	<i>InvoiceRequest /SalesBookInvoice/TaxesPerSeller/FlatRateCompensation/FlatRateTaxableAmount</i>
R_4.11.33	++++ Znesek pavšalnega nadomestila / <i>Amount of the flat-rate compensation</i>	Znesek pavšalnega nadomestila. / <i>Amount of the flat-rate compensation</i>  Decimalno ločilo je pika. / <i>The decimal separator is a dot.</i>	DA, če obstaja pavšalno nadomestilo / <i>YES if the flat-rate compensation exists</i>	<i>Decimal Number</i>	Številka / <i>Numbers:</i> max 14  Decimali / <i>Decimals:</i> max 2	<i>InvoiceRequest /SalesBookInvoice/TaxesPerSeller/FlatRateCompensation/FlatRateAmount</i>
R_4.11.4	+++ Ostali davki/dajatve / <i>Other taxes/duties</i>	Vpiše se skupni znesek ostalih davkov oziroma dajatev (razen DDV), ki so na računu. / <i>The total amount is entered of other taxes or duties (except VAT), which are on the invoice.</i>  Podatek se vpisuje le, če račun vsebuje davke oziroma dajatve, ki niso DDV. / <i>The data is entered only if the invoice includes taxes or duties, which are not VAT.</i>  Decimalno ločilo je pika. / <i>The decimal separator is a dot.</i>	DA, če obstaja davek/dajatev / <i>YES if the tax/duty exists</i>	<i>Decimal Number</i>	Številka / <i>Numbers:</i> max 14  Decimali / <i>Decimals:</i> max 2	<i>InvoiceRequest /SalesBookInvoice/TaxesPerSeller/OtherTaxesAmount</i>

R_4.11.5	+++ Vrednost oproščenih dobav / <i>Value of exempt supplies</i>	Skupna vrednost dobav blaga ali storitev na računu, ki so v skladu z Zakonom o davku na dodano vrednost oproščene plačila DDV (po zmanjšanju za popuste). / <i>The total value of supplies of goods or services on the account, which are in accordance with the Value Added Tax Act exempt from VAT payment (after reduction for discounts).</i>  Podatek se vpiše le, če na računu obstaja znesek oproščenih dobav. / <i>The data is entered only if the amount of exempt supplies exists on the invoice.</i>  Decimalno ločilo je pika. / <i>The decimal separator is a dot.</i>	DA, če obstajajo takšne dobave / <i>YES if such supplies exist</i>	<i>Decimal Number</i>	Številka / <i>Numbers:</i> max 14  Decimalna / <i>Decimals:</i> max 2	<i>InvoiceRequest /SalesBookInvoice/TaxesPerSeller/ExemptVAT TaxableAmount</i>
R_4.11.6	+++ Vrednost dobav po 76.a členu Zakona o davku na dodano vrednost / <i>Value of supplies on the basis of Article 76.a of the Value Added Tax Act</i>	Vrednost dobav za katere je v skladu s 76.a členom Zakona o davku na dodano vrednost prejemnik blaga ali storitev plačnik DDV - obrnjena davčna obveznost (po zmanjšanju za popuste). / <i>The value of supplies, for which in accordance with Article 76.a of the Value Added Tax</i>	DA, če obstajajo takšne dobave / <i>YES if such supplies exist</i>	<i>Decimal Number</i>	Številka / <i>Numbers:</i> max 14  Decimalna / <i>Decimals:</i> max 2	<i>InvoiceRequest /SalesBookInvoice/TaxesPerSeller/ReverseVAT TaxableAmount</i>

		<p><i>Act the recipient of goods or services is the payer of VAT – reverse charge procedure (after reduction for discounts).</i></p> <p>Podatek se vpiše le, če na računu obstajajo takšne dobave. / <i>The data is entered only if such supplies exist on the invoice.</i></p> <p>Decimalno ločilo je pika. / <i>The decimal separator is a dot.</i></p>				
R_4.11.7	+++ Vrednost neobdavčljivih dobav / <i>Value of non-taxable supplies</i>	<p>Vrednost neobdavčljivih dobav blaga ali storitev na računu (po zmanjšanju za popuste). Podatek se vpiše le, če na računu obstaja vrednost dobav, ki v skladu z Zakonom o davku na dodano vrednost niso predmet DDV. / <i>The value of non-taxable supplies of goods or services on the invoice (after reduction for discounts). The data is entered only if on the invoice there is such value of supplies, which in accordance with the VAT Act are not subject to VAT.</i></p> <p>Decimalno ločilo je pika. / <i>The decimal separator is a dot.</i></p>	DA, če obstajajo takšne dobave / <i>YES if such supplies exist</i>	<i>Decimal Number</i>	Številka / <i>Numbers:</i> max 14 Decimalna / <i>Decimals:</i> max 2	<i>InvoiceRequest /SalesBookInvoice/TaxesPerSeller/Nontaxable Amount</i>



R_4.11.8	+++ Vrednost dobav, ki se nanaša na posebne ureditve / <i>Value of supplies, which refers to special arrangements</i>	Vrednost dobav, za katere se uporablja posebna ureditev, po kateri se obdavčuje razlika v ceni, in sicer posebna ureditev za rabljeno blago, umetniške predmete, zbirke in starine (101. člen Zakona o davku na dodano vrednost). Vpiše se tudi vrednost dobav za katere se obračunava in plačuje DDV po posebni ureditvi za potovalne agencije (97. člen Zakona o davku na dodano vrednost). Vpiše se znesek, ki je zmanjšan za popuste. / <i>The value of supplies, for which the special arrangement is used, according to which the margin is taxed, i.e. special arrangement for second-hand goods, works of art, collector's items and antiques (Article 101 of the VAT Act). The value of supplies is also entered, for which VAT is settled and paid in accordance with the special arrangement for travel agencies (Article 97 of the VAT Act). The amount is entered, which is decreased for discounts.</i>  Decimalno ločilo je pika. / <i>The decimal</i>	DA, če obstajajo takšne dobave / <i>YES if such supplies exist</i>	<i>Decimal Number</i>	Številka / <i>Numbers:</i> max 14  Decimali / <i>Decimals:</i> max 2	<i>InvoiceRequest /SalesBookInvoice/TaxesPerSeller/SpecialTax RulesAmount</i>
----------	---	---	--	-----------------------	--	---

		<i>separator is a dot.</i>				
R_4.12	++ Številka računa iz vezane knjige računov, ki se spreminja / <i>Number of the invoice from the pre-numbered invoice book, which is changed</i>	<p>Vpiše se številka prvotnega računa iz vezane knjige računov, ki se spreminja. / <i>The number of the original invoice is entered from the pre-numbered invoice book, which is changed.</i></p> <p>Zavezanec izvaja postopek potrjevanja računov tudi za vse naknadne spremembe podatkov na računu, ki spreminjajo prvoten račun in se nanj nedvoumno nanašajo. / <i>The person liable performs the procedure for verification of invoices also for all subsequent changes of data on the invoice, which change the original invoice and refer to it with reasonable certainty.</i></p> <p>Podatek se vpiše v primeru, če se z računom, izdanim iz vezane knjige računov, spreminja prvoten račun, ki je bil izdan iz vezane knjige računov. / <i>The data is entered in cases when the original invoice, which has been issued from the pre-numbered invoice book, changes with the</i></p>	DA, če se spreminja prvoten račun iz vezane knjige računov / <i>YES if the original invoice from the pre-numbered invoice book is changed</i>	<i>Text</i>	<i>Min1, Max20</i>	<i>InvoiceRequest /SalesBookInvoice/ReferenceSalesBook/ReferenceSalesBookIdentifier/InvoiceNumber</i>

		<i>invoice, issued from the pre-numbered invoice book.</i>				
R_4.13	++ Številka seta računa iz vezane knjige računov, ki se spreminja / <i>Number of the invoice set (original invoice + its two copies) from the pre-numbered invoice book, which is changed</i>	Vpiše se številka posameznega obrazca prvotnega računa (seta) izdanega iz vezane knjige računov, ki se spreminja. / <i>The number is entered of an individual form of the original invoice (set) issued from the pre-numbered invoice book, which is changed.</i>  Podatek se vpiše v primeru, če se z računom, izdanim iz vezane knjige računov, spreminja prvoten račun, ki je bil izdan iz vezane knjige računov. / <i>The data is entered in cases if the original invoice, which has been issued from the pre-numbered invoice book, is changed with the invoice, issued from the pre-numbered invoice book.</i>	DA, če se spreminja prvoten račun iz vezane knjige računov / <i>YES if the original invoice from the pre-numbered invoice book is changed</i>	<i>Text</i>	<i>Min2, Max2</i>	<i>InvoiceRequest /SalesBookInvoice/ReferenceSalesBook/ReferenceSalesBookIdentifier/SetNumber</i>
R_4.14	++ Serijska številka vezane knjige računov iz katere je bil izdan račun, ki se spreminja / <i>Serial number</i>	Vpiše se serijska številka vezane knjige računov iz katere je bil izdan prvotni račun, ki se spreminja. / <i>The serial number is entered of the pre-numbered invoice</i>	DA, če se spreminja prvoten račun iz vezane knjige računov / <i>YES if the original invoice from the pre-numbered invoice book is changed</i>	<i>Text</i>	<i>Min12, Max12</i>	<i>InvoiceRequest /SalesBookInvoice/ReferenceSalesBook/ReferenceSalesBookIdentifier/Serial Number</i>

	<i>of the pre-numbered invoice book, from which the invoice has been issued, which is changed</i>	<i>book, from which the original invoice has been issued, which is changed.</i>  Podatek se vpiše v primeru, če se z računom, izdanim iz vezane knjige računov, spreminja prvoten račun, ki je bil izdan iz vezane knjige računov. / <i>The data is entered in cases if the original invoice, which has been issued from the pre-numbered invoice book, is changed with the invoice, issued from the pre-numbered invoice book.</i>				
R_4.15	<b>++</b> Datum izdaje računa iz vezane knjige računov, ki se spreminja / <i>Date of issuing the invoice from the pre-numbered invoice book, which is changed</i>	Vpiše se datum izdaje prvotnega računa iz vezane knjige računov, ki se spreminja, če se spreminja prvoten račun izdan iz vezane knjige računov. / <i>The date is entered of issuing the original invoice from the pre-numbered invoice book, which is changed, if the original invoice is changed issued from the pre-numbered invoice book.</i>  Podatek se vpiše v formatu LLLL-MM-DD. / <i>The data is written in the</i>	NE / NO	<i>Date</i>		<i>InvoiceRequest /SalesBookInvoice/ReferenceSalesBook/ReferenceSalesBook IssueDate</i>

		<p><i>following format: YYYY-MM-DD.</i></p> <p>Podatek se vpiše v primeru, če se z računom, izdanim iz vezane knjige računov, spreminja prvoten račun, ki je bil izdan iz vezane knjige računov. / <i>The data is entered in cases when the original invoice, which has been issued from the pre-numbered invoice book, is changed with the invoice, issued from the pre-numbered invoice book.</i></p>				
R_4.16	<p>++ Številka računa, izdanega preko elektronske naprave, ki se spreminja / <i>Number of the invoice, issued via the electronic device, which is changed</i></p>	<p>Vpiše se številka prvotnega računa v primeru naknadne spremembe podatkov na prvotnem računu, če je bil prvoten račun izdan preko elektronske naprave. / <i>The number is entered of the original invoice in cases of subsequent changes of data on the original invoice if the original invoice has been issued via the electronic device.</i></p> <p>Podatek se vpiše v primeru, če se z računom, izdanim iz vezane knjige računov, spreminja</p>	<p>DA, če se spreminja prvoten račun, ki je bil izdan preko elektronske naprave / <i>YES if the original invoice is changed which has been issued via the electronic device</i></p>			<p><i>InvoiceRequest /SalesBookInvoice/ReferenceInvoice/ReferenceIdentifier</i></p>

		<p>prvoten račun, ki je bil izdan preko elektronske naprave. / <i>The data is entered in cases when the original invoice, which has been issued via the electronic device, is changed with the invoice, issued from the pre-numbered invoice book.</i></p> <p>Za vpis številke računa, ki se spreminja, veljajo enaka pravila kot pri vpisu številke računa. Številka računa je sestavljena iz treh delov / <i>For entry of the number of the invoice, which is changed, the same rules apply as for entry of the number of the invoice. The number of the invoice includes three parts:</i></p> <ul style="list-style-type: none"> <li>- Oznaka poslovnega prostora / <i>Mark of business premises</i></li> <li>- Oznaka elektronske naprave za izdajanje računov / <i>Mark of the electronic device for issuing invoices</i></li> <li>- Zaporedna številka računa / <i>Sequence invoice number</i></li> </ul>			
--	--	---	--	--	--

		<p>Številka računa se na računu navede v naslednji obliki / <i>The number of the invoice is stated on the invoice in the following form:</i></p> <p>oznaka poslovnega prostora-oznaka elektronske naprave-zaporedna številka računa / <i>mark of business premises-mark of the electronic device-sequence number of the invoice</i></p> <p>Primer / <i>Example:</i> TRGOVINA1-BLAG2-1234</p> <p>Podatki se vpisujejo ločeno. / <i>Data are entered separately.</i></p>				
R_4.16.1	+++ Oznaka poslovnega prostora / <i>Mark of business premises</i>	Vsebuje lahko samo črke in številke / <i>It may include only the following letters and numbers: 0-9, a-z, A-Z.</i>	DA, če se spreminja prvoten račun, ki je bil izdan preko elektronske naprave / <i>YES if the original invoice is changed which has been issued via the electronic device</i>	<i>Text</i>	<i>Min1, Max20</i>	<i>InvoiceRequest/SalesBookInvoice/ReferenceInvoice/ReferenceInvoiceIdentifier/BusinessPremiseID</i>
R_4.16.2	+++ Oznaka elektronske naprave / <i>Mark of the electronic device</i>	Vsebuje lahko samo črke in številke / <i>It may include only the following letters and numbers: 0-9, a-z, A-Z.</i>	DA, če se spreminja prvoten račun, ki je bil izdan preko elektronske naprave / <i>YES if the original invoice is changed which has been issued via the electronic device</i>	<i>Text</i>	<i>Min1, Max20</i>	<i>InvoiceRequest/SalesBookInvoice/ReferenceInvoice/ReferenceInvoiceIdentifier/ElectronicDeviceID</i>

R_4.16.3	+++ Zaporedna številka računa / <i>Sequence number of the invoice</i>	Vsebuje lahko samo številke 0-9. Niso dovoljene vodilne ničle. / <i>It may include only numbers 0-9. Zeros cannot be on the first place.</i>	DA, če se spreminja prvoten račun, ki je bil izdan preko elektronske naprave / <i>YES if the original invoice is changed which has been issued via the electronic device</i>	<i>Text</i>	<i>Min1, Max20</i>	<i>InvoiceRequest /SalesBookInvoice/ReferenceInvoice/ReferenceInvoiceIdentifier/InvoiceNumber</i>
R_4.17	++ Datum in čas izdaje računa, izdanega preko elektronske naprave, ki se spreminja / <i>Date and time of issuing the invoice, issued via the electronic device, which is changed</i>	Vpiše se datum in čas prvotnega računa v primeru naknadne spremembe podatkov na prvotnem računu, če je bil prvoten račun izdan preko elektronske naprave. / <i>The date and time are entered of issuing the original invoice in cases of subsequent changes of data on the original invoice if the original invoice has been issued via the electronic device.</i>  Podatek se vpiše v primeru, če se z računom, izdanim iz vezane knjige računov, spreminja prvoten račun, ki je bil izdan preko elektronske naprave. / <i>The data is entered in cases when the original invoice, which has been issued via the electronic device, is changed with the invoice, issued from the pre-numbered invoice book.</i>	NE / <i>NO</i>	<i>Date Time</i>		<i>InvoiceRequest /SalesBookInvoice/ReferenceInvoice/ReferenceInvoiceIssueDateTime</i>



		Podatek se vpiše v formatu LLLL-MM-DDTUU:MM:SS. / <i>The data is entered in the following format:</i>  YYYY-MM-DDTHH:MM:SS.				
R_4.18	++ Ostalo / <i>Other</i>	Vpišejo se morebitne druge oznake, ki podrobneje pojasnjujejo zapise v zvezi z vsebino izdanih računov in njihove spremembe. / <i>Any potential other marks are entered, which explain in detail the records in connection with the content of issued invoices and their changes.</i>	NE / NO	<i>Text</i>	<i>Min1, Max1000</i>	<i>InvoiceRequest /SalesBookInvoice/SpecialNotes</i>

### 3.1.2. SHEMA SPOROČILA TIPA RAČUN / SCHEMA OF THE MESSAGE OF THE INVOICE TYPE

Iz zgornjega poglavja o vsebini sporočil tipa račun sledi, da lahko sporočilo tipa račun vsebuje samo enega izmed naslednjih dveh naborov podatkov / *From the chapter above on the content of messages of the invoice type it is evident that the message of the invoice type may include only one of the following two sets of data:*

- podatke o računu izdanem preko elektronske naprave / *data about the invoice issued via the electronic device*
- podatke o računu izdanem preko vezane knjige računov / *data about the invoice issued via the pre-numbered invoice book.*

Če je račun izdan preko elektronske naprave, vsebuje element / *If the invoice is issued via the electronic device, it includes the following element* <fu:Invoice>; če je izdan preko vezane knjige računov vsebuje element / *if it is issued via the pre-numbered invoice book, it includes the following element* <fu:SalesBookInvoice>.

Sledeća diagrama prikazujeta shemo sporočila tipa račun. Prvi diagram prikazuje detaljniju strukturu elementa / *The following diagrams present the schema of the message of the invoice type. The first diagram presents a detailed structure of the element <fu:Invoice>, drugi pa prikazuje detaljniju strukturu elementa / and the second one presents a detailed structure of the element <fu:SalesBookInvoice>.*

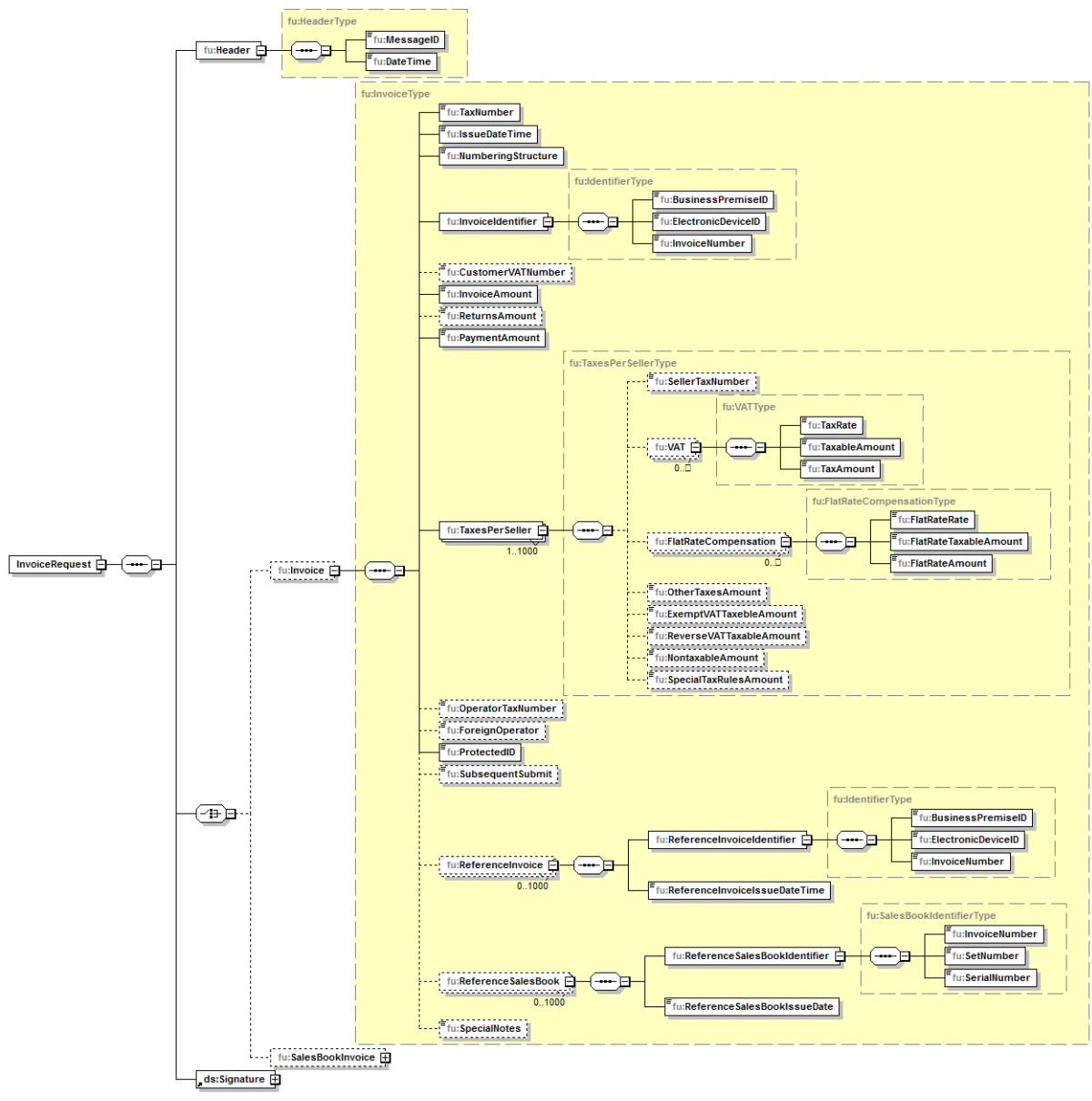

Generated by XMLSpy [www.altova.com](http://www.altova.com)

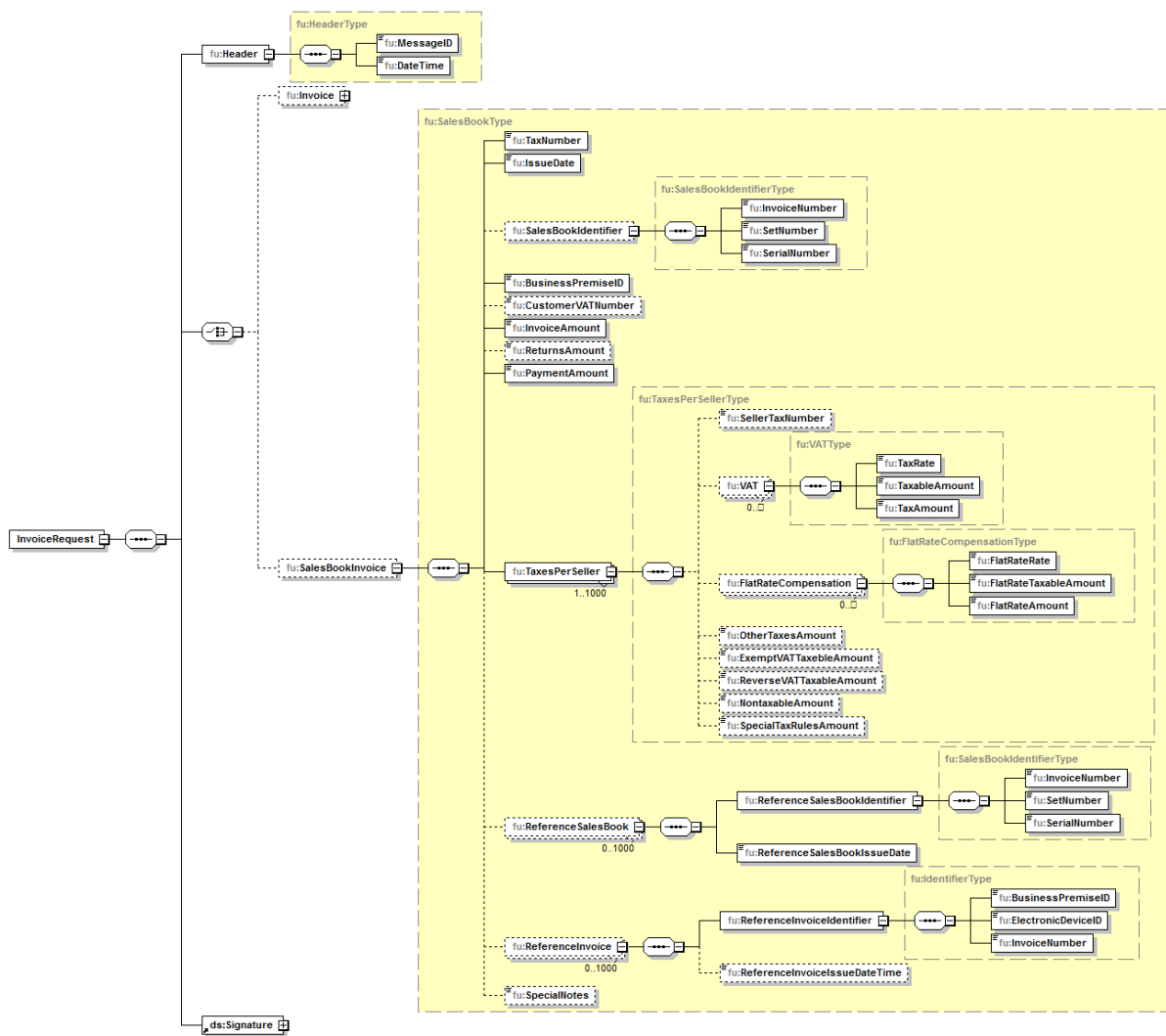

Generated by XMLSpy [www.altova.com](http://www.altova.com)

### 3.1.3. PRIMER SPOROČILA TIPA RAČUN IZDANEGA PREKO ELEKTRONSKE NAPRAVE / EXAMPLE OF THE MESSAGE OF THE INVOICE TYPE ISSUED VIA THE ELECTRONIC DEVICE

Spodnji primer sporočila tipa račun izdanega preko elektronske naprave, kateri vsebuje podatke, ki so testni in niso nujno vsebinsko pravilni. / The example below for the message of the invoice type issued via the electronic device, which includes test data and their content is not necessarily substantively accurate.

```
<fu:InvoiceRequest Id="test">
  <fu:Header>
    <fu:MessageID>4e64a93a-40fa-4c02-afb1-488534b85e4c</fu:MessageID>
    <fu:DateTime>2015-08-07T13:05:24</fu:DateTime>
  </fu:Header>
  <fu:Invoice>
    <fu:TaxNumber>99999862</fu:TaxNumber>
    <fu:IssueDateTime>2015-08-07T13:05:24</fu:IssueDateTime>
    <fu:NumberingStructure>B</fu:NumberingStructure>
    <fu:InvoiceIdentifier>
      <fu:BusinessPremiseID>TRGOVINA1</fu:BusinessPremiseID>
      <fu:ElectronicDeviceID>BLAG2</fu:ElectronicDeviceID>
      <fu:InvoiceNumber>145</fu:InvoiceNumber>
    
```

```

</fu:InvoiceIdentifier>
<fu:InvoiceAmount>66.71</fu:InvoiceAmount>
<fu:PaymentAmount>1047.76</fu:PaymentAmount>
<fu:TaxesPerSeller>
  <fu:VAT>
    <fu:TaxRate>22.00</fu:TaxRate>
    <fu:TaxableAmount>23.14</fu:TaxableAmount>
    <fu:TaxAmount>5.09</fu:TaxAmount>
  </fu:VAT>
  <fu:VAT>
    <fu:TaxRate>9.50</fu:TaxRate>
    <fu:TaxableAmount>35.14</fu:TaxableAmount>
    <fu:TaxAmount>3.34</fu:TaxAmount>
  </fu:VAT>
</fu:TaxesPerSeller>
<fu:OperatorTaxNumber>12345678</fu:OperatorTaxNumber>
<fu:ProtectedID>34905bcff14b381039af2e9d7eee54bb</fu:ProtectedID>
</fu:Invoice>
</fu:InvoiceRequest>

```

### 3.1.4. PRIMER SPOROČILA TIPA RAČUN IZDANEGA PREKO VEZANE KNJIGE RAČUNOV / EXAMPLE OF THE MESSAGE OF THE INVOICE TYPE ISSUED VIA THE PRE-NUMBERED INVOICE BOOK

Spodnji primer sporočila tipa račun izdanega preko vezane knjige računov, kateri vsebuje podatke, ki so testni in niso nujno vsebinsko pravilni. / *The example below for the message of the invoice type issued via the pre-numbered invoice book, which includes test data and their content is not necessarily substantively accurate.*

```

<fu:InvoiceRequest Id="test">
  <fu:Header>
    <fu:MessageID>ef60b025-3f8e-43f8-8a7a-905095dc225f</fu:MessageID>
    <fu:DateTime>2015-08-07T13:48:23</fu:DateTime>
  </fu:Header>
  <fu:SalesBookInvoice>
    <fu:TaxNumber>99999862</fu:TaxNumber>
    <fu:IssueDate>2016-04-10</fu:IssueDate>
    <fu:SalesBookIdentifier>
      <fu:InvoiceNumber>612</fu:InvoiceNumber>
      <fu:SetNumber>03</fu:SetNumber>
      <fu:SerialNumber>5001-0001018</fu:SerialNumber>
    </fu:SalesBookIdentifier>
    <fu:BusinessPremiseID>TRGOVINA1</fu:BusinessPremiseID>
    <fu:InvoiceAmount>1060.06</fu:InvoiceAmount>
    <fu>ReturnsAmount>12.30</fu>ReturnsAmount>
    <fu:PaymentAmount>1047.76</fu:PaymentAmount>
    <fu:TaxesPerSeller>
      <fu:VAT>
        <fu:TaxRate>22.00</fu:TaxRate>
        <fu:TaxableAmount>36.89</fu:TaxableAmount>
        <fu:TaxAmount>8.12</fu:TaxAmount>
      </fu:VAT>
    </fu:TaxesPerSeller>
  </fu:SalesBookInvoice>
</fu:InvoiceRequest>

```

```

    <fu:VAT>
      <fu:TaxRate>9.50</fu:TaxRate>
      <fu:TaxableAmount>56.53</fu:TaxableAmount>
      <fu:TaxAmount>5.37</fu:TaxAmount>
    </fu:VAT>
    <fu:OtherTaxesAmount>53.89</fu:OtherTaxesAmount>
  <fu:ExemptVATTaxableAmount>142.87</fu:ExemptVATTaxableAmount>
  <fu:ReverseVATTaxableAmount>67.34</fu:ReverseVATTaxableAmount>
    <fu:NontaxableAmount>43.87</fu:NontaxableAmount>
    <fu:SpecialTaxRulesAmount>87.23</fu:SpecialTaxRulesAmount>
  </fu:TaxesPerSeller>
  <fu:TaxesPerSeller>
    <fu:SellerTaxNumber>82730341</fu:SellerTaxNumber>
  </fu:TaxesPerSeller>
  <fu:VAT>
    <fu:TaxRate>22.00</fu:TaxRate>
    <fu:TaxableAmount>37.42</fu:TaxableAmount>
    <fu:TaxAmount>8.23</fu:TaxAmount>
  </fu:VAT>
  <fu:VAT>
    <fu:TaxRate>9.50</fu:TaxRate>
    <fu:TaxableAmount>88.99</fu:TaxableAmount>
    <fu:TaxAmount>8.45</fu:TaxAmount>
  </fu:VAT>
  <fu:OtherTaxesAmount>65.53</fu:OtherTaxesAmount>
  <fu:ExemptVATTaxableAmount>45.38</fu:ExemptVATTaxableAmount>
  <fu:ReverseVATTaxableAmount>54.83</fu:ReverseVATTaxableAmount>
    <fu:NontaxableAmount>245.14</fu:NontaxableAmount>
    <fu:SpecialTaxRulesAmount>3.98</fu:SpecialTaxRulesAmount>
  </fu:TaxesPerSeller>
</fu:SalesBookInvoice>
</fu:InvoiceRequest>

```

### 3.1.5. VSEBINA IN OBLIKA ODGOVORA NA SPOROČILO TIPA RAČUN / CONTENT AND FORM OF THE RESPONSE TO THE MESSAGE OF THE INVOICE TYPE

Nabor podatkov za odgovor na sporočilo tipa račun. / *Set of data for the response to the message of the invoice type*

Ime elementa / Element name	Uporaba/opis elementa / Usage/description of the element	Obvezen podatek / Obligatory data DA/NE / YES/NO	Tip podatka / Type of data	Zaloga vrednosti / Stock of values
+ Glava sporočila / Message header				
++ Identifikator sporočila / Message identifier	Identifikator sporočila iz sporočila tipa račun. / Message identifier from the message of the invoice type	DA / YES	Text	Min36, Max 36
++ Datum in čas pošiljanja / Date and time of sending	Datum in čas pošiljanja sporočila. / Date and time of sending the message LLLL-MM-DDTUU:MM:SS / YYYY-MM-DDTHH:MM:SS	DA / YES	Date Time	
+ Enkratna identifikacijska oznaka računa /	Vrne se enkratna identifikacijska oznaka računa (EOR). V primeru napake se ne vrne. / The unique identification invoice mark (EOR) is returned. In	NE / NO	Text (36)	Min36, Max 36

Unique identification invoice mark	cases of errors it doesn't return.			
+ Napake / Errors		NE / NO		
++Šifrant napake / Error code table	Napaka je opisana s formatom sXXX, kjer je XXX tri znakovna številka. / The error is described with sXXXformat, where XXX presents a three-character digit.	NE / NO		
++Opis napake / Error description	Opisna napaka. / Description error	NE / NO		

### 3.1.6. SHEMA ODGOVORA NA SPOROČILO TIPA RAČUN / SCHEMA OF THE RESPONSE TO THE MESSAGE OF THE INVOICE TYPE

Sledeča slika prikazuje shemo odgovora na sporočilo tipa račun. / The following picture presents the schema of the response to the message of the invoice type.

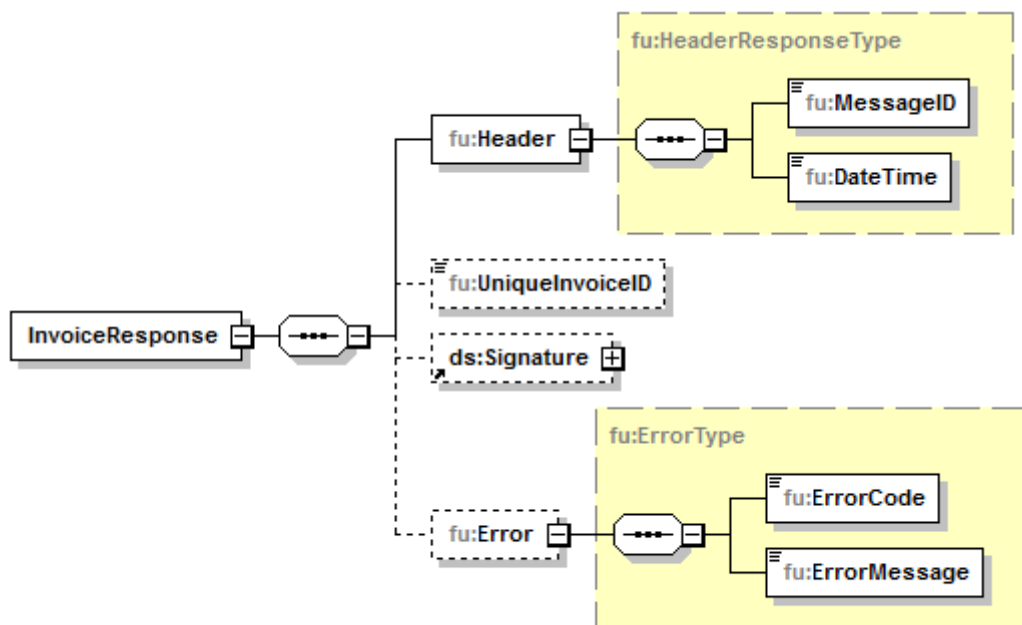

Generated by XMLSpy

www.altova.com

### 3.1.7. PRIMER ODGOVORA NA SPOROČILO TIPA RAČUN / EXAMPLE OF THE RESPONSE TO THE MESSAGE OF THE INVOICE TYPE

Spodnja primera odgovora na sporočilo tipa račun vsebujeta podatke, ki so testni in niso nujno vsebinsko pravilni. *The two examples below for the response to the message of the invoice type include test data and their content is not necessarily substantively accurate.*

Primer brez napake / *Example without an error:*

```
<fu:InvoiceResponse Id="data">
  <fu:Header>
    <fu:DateTime>2015-08-07T13:06:52.631Z</fu:DateTime>
    <fu:MessageID>4e64a93a-40fa-4c02-afb1-488534b85e4c</fu:MessageID>
  </fu:Header>
  <fu:UniqueInvoiceID>b5f1c310-3dea-4331-82f8-d2dc72d9d018</fu:UniqueInvoiceID>
</fu:InvoiceResponse>
```

Primer z napako / *Example with an error:*

```
<fu:InvoiceResponse Id="data">
  <fu:Header>
    <fu:DateTime>2015-08-07T13:09:10.879Z</fu:DateTime>
    <fu:MessageID>593700da-5780-4380-be46-cf4a5cd89e8e</fu:MessageID>
  </fu:Header>
  <fu>Error>
    <fu:ErrorCode>s001</fu:ErrorCode>
    <fu:ErrorMessage>Sporočilo ni v skladu z XML shemo.</fu:ErrorMessage>
  </fu>Error>
</fu:InvoiceResponse>
```

## 3.2. PODATKI O POSLOVNEM PROSTORU / DATA ABOUT BUSINESS PREMISES

Sledeč diagram opisuje proces izdaje sporočila s podatki o poslovnem prostoru. / The following diagram describes the process of issuing the message with data about business premises.

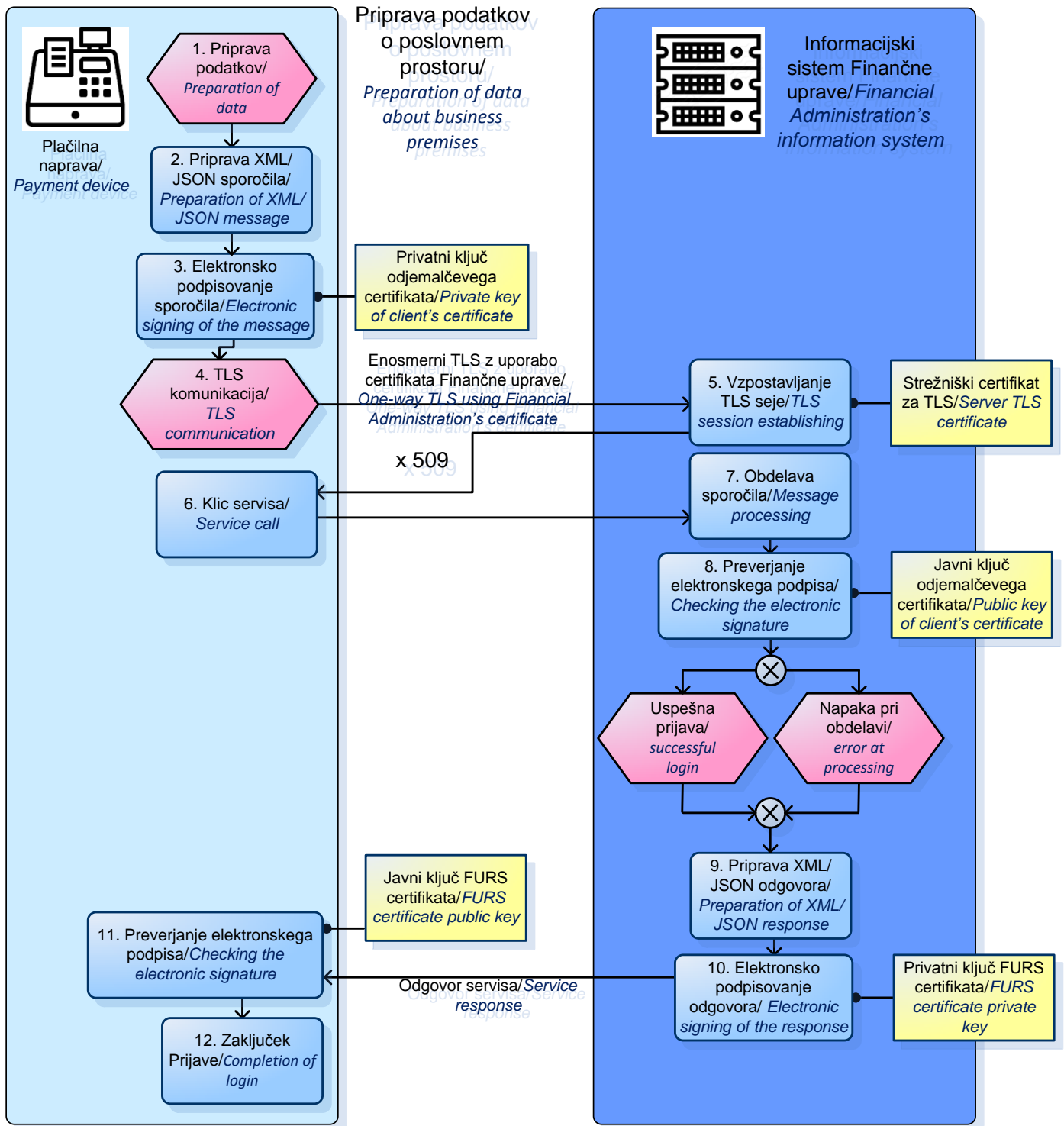



### 3.2.1. VSEBINA IN OBLIKA SPOROČILA TIPA POSLOVNI PROSTOR / CONTENT AND FORM OF THE MESSAGE OF THE BUSINESS PREMISES TYPE

Spodnja tabela prikazuje nabor podatkov ter njihovo obliko v sporočilu tipa poslovni prostor. / *The table below presents the set of data and their form in the message of the business premises type.*

Indeks / <i>Index</i>	Ime elementa / <i>Name of the element</i>	Uporaba/opis elementa / <i>Usage/description of the element</i>	Obvezen Podatek / <i>Obligatory data</i> DA/NE / <i>YES/NO</i>	Tip podatka / <i>Data type</i>	Zaloga vrednosti / <i>Stock of values</i>	XML element
<i>Glava sporočila / Message header</i>						
P_1.0	+ Identifikator sporočila / <i>Identifier of the message</i>	Enkratni identifikator sporočila. / <i>Unique identifier of the message</i> Vsako sporočilo mora imeti enkratno identifikacijsko oznako. Enako velja tudi pri pošiljanju sporočila, ki se zaradi napake pošilja ponovno. / <i>Every message shall have the unique identification mark. The same is valid also for sending messages, which are resent due to errors.</i>	Da / <i>Yes</i>	<i>Text</i>	<i>Min36, Max36</i>	<i>BusinessPremiseRequest/Header/MessageID</i>
P_2.0	+ Datum in čas pošiljanja / <i>Date and time of sending</i>	Datum in čas pošiljanja sporočila. / <i>Date and time of sending the message</i> LLLL-MM-DDTUU:MM:SS / <i>YYYY-MM-DDTHH:MM:SS</i>	Da / <i>Yes</i>	<i>Date Time</i>		<i>BusinessPremiseRequest/Header/DateTime</i>
<i>Poslovni prostor / Business premises</i>						
P_3.0	+ Davčna številka / <i>Tax number</i>	Davčna številka zavezanca, ki izdaja račune / <i>Tax number of the person liable, who issues invoices</i>	DA / <i>Yes</i>	<i>Text</i>	<i>Min8, Max8</i>	<i>BusinessPremiseRequest/BusinessPremise/Tax Number</i>
P_4.0	+ Oznaka poslovnega prostora / <i>Mark of business premises</i>	Vpiše se oznaka poslovnega prostora v katerem zavezanec izdaja račune pri gotovinskem poslovanju. Oznaka je lahko sestavljena iz števil in črk / <i>The mark is entered of business premises, in which the person liable issues invoices in cash operations. The mark may include the following number and letters: / 0-9, a-z, A-Z.</i> Oznaka mora biti enaka kot tista, ki je navedena na	DA / <i>Yes</i>	<i>Text</i>	<i>Min1, Max20</i>	<i>BusinessPremiseRequest/BusinessPremise/BusinessPremiseID</i>

		<p>računih. / <i>The mark shall be the same as the mark, stated on invoices.</i></p> <p>Oznaka je enkratna na nivoju zavezanca. / <i>The mark is unique at the level of the person liable.</i></p>				
P_5.0	<p>+ Identifikacijski podatki o poslovnem prostoru / <i>Identification data about business premises</i></p>	<p>Vpišejo se podatki o nepremičnem ali premičnem poslovnem prostoru. / <i>Data are entered about immovable or movable business premises.</i></p>	DA / <i>Yes</i>			<i>BusinessPremiseRequest/BusinessPremise/BPIDentifier</i>
P_5.1	<p>++ Nepremični poslovni prostor / <i>Immovable business premises</i></p>	<p>Vpišejo se podatki o nepremičnem poslovnem prostoru, če zavezanec izdaja račune v nepremičnem poslovnem prostoru. / <i>Data about immovable business premises are entered if the person liable issues invoices in immovable business premises.</i></p>	DA, če zavezanec izdaja račune v nepremičnem poslovnem prostoru / <i>YES if the person liable issues invoices in immovable business premises</i>			<i>BusinessPremiseRequest/BusinessPremise/BPIDentifier/RealEstateBP</i>
P_5.11	<p>+++ Identifikacijska oznaka nepremičnine / <i>Identification mark of the immovable property</i></p>	<p>Vpiše se identifikacijska oznaka stavbe oziroma dela stavbe, kjer se nahaja poslovni prostor, kot je določena v registru nepremičnin. Oznaka se vpiše, če zavezanec izdaja račune v nepremičnem poslovnem prostoru. / <i>The identification mark of the building or part of the building is entered, where business premises are located, as it is defined in the register of immovable property. The mark is entered if the person liable issues invoices in immovable business premises.</i></p> <p>Identifikacijska oznaka nepremičnine je sestavljena iz treh delov / <i>The identification mark of the immovable property consists of three parts:</i></p> <ul style="list-style-type: none"> <li>- Številka katastrske občine / <i>Number of the cadastral community</i></li> </ul>	DA / <i>YES</i>			<i>BusinessPremiseRequest/BusinessPremise/BPIDentifier/RealEstateBP/PropertyID</i>

		<ul style="list-style-type: none"> <li>- Številka stavbe / <i>Number of the building</i></li> <li>- Številka dela stavbe / <i>Number of the part of the building</i></li> </ul> <p>Podatki se vpisujejo ločeno. / <i>Data are entered separately.</i></p>				
P_5.111	++++ Številka katastrske občine / <i>Number of the cadastral community</i>		DA / YES	<i>Number</i>	Številka / <i>Numbers:</i> max 4	<i>BusinessPremiseRequest/BusinessPremise/BPIDentifier/RealEstateBP/PropertyID/CadastralNumber</i>
P_5.112	++++ Številka stavbe / <i>Number of the building</i>		DA / YES	<i>Number</i>	Številka / <i>Numbers:</i> max 5	<i>BusinessPremiseRequest/BusinessPremise/BPIDentifier/RealEstateBP/PropertyID/BuildingNumber</i>
P_5.113	++++ Številka dela stavbe / <i>Number of the part of the building</i>		DA / YES	<i>Number</i>	Številka / <i>Numbers:</i> max 4	<i>BusinessPremiseRequest/BusinessPremise/BPIDentifier/RealEstateBP/PropertyID/BuildingSectionNumber</i>
P_5.12	+++ Naslov poslovnega prostora / <i>Address of business premises</i>	<p>Vpiše se naslov poslovnega prostora, če zavezanec izdaja račune v nepremičnem poslovnem prostoru. / <i>The address of business premises is entered if the person liable issues invoices in immovable business premises.</i></p> <p>Naslov sestavljajo ulica in hišna številka, dodatek k hišni številki, naselje, pošta in poštna številka. / <i>The address includes: street, house number, addition to the house number, town, post office and postcode.</i></p>	DA / YES			<i>BusinessPremiseRequest/BusinessPremise/BPIDentifier/RealEstateBP/Address</i>
P_5.121	++++ Ulica / <i>Street</i>		DA / YES	<i>Text</i>	Min1, Max100	<i>BusinessPremiseRequest/BusinessPremise/BPIDentifier/RealEstateBP/Address/Street</i>
P_5.122	++++ Hišna številka / <i>House number</i>		DA / YES	<i>Text</i>	Min1, Max10	<i>BusinessPremiseRequest/BusinessPremise/BPIDentifier/RealEstateBP/Address/HouseNumber</i>

						<i>tateBP/Address/HouseNumber</i>
P_5.123	++++ Dodatek k hišni številki / <i>Addition to the house number</i>		DA, če obstaja / <i>YES if it exists</i>	<i>Text</i>	<i>Min1, Max10</i>	<i>BusinessPremiseRequest/BusinessPremise/BPIDentifier/RealEstateBP/Address/HouseNumberAdditional</i>
P_5.124	++++ Naselje / <i>Town</i>		DA / <i>YES</i>	<i>Text</i>	<i>Min1, Max100</i>	<i>BusinessPremiseRequest/BusinessPremise/BPIDentifier/RealEstateBP/Address/Community</i>
P_5.125	++++ Pošta / <i>Post office</i>		DA / <i>YES</i>	<i>Text</i>	<i>Min1, Max40</i>	<i>BusinessPremiseRequest/BusinessPremise/BPIDentifier/RealEstateBP/Address/BusinessPremise/City</i>
P_5.126	++++ Poštna številka / <i>Postcode</i>		DA / <i>YES</i>	<i>Text</i>	<i>Min4, Max4</i>	<i>BusinessPremiseRequest/BusinessPremise/BPIDentifier/RealEstateBP/Address/BusinessPremise/PostalCode</i>
P_5.2	++ Premični poslovni prostor / <i>Movable business premises</i>	Vpiše se vrsta poslovnega prostora, če zavezanec izdaja račune v premičnem poslovnem prostoru / <i>The type of business premises is entered if the person liable issues invoices in movable business premises:</i> A – premičen objekt (npr. prevozno sredstvo, premična stojnica) ali / <i>movable object (e.g. vehicle, movable stand) or</i> B – objekt na stalni lokaciji (npr. stojnica na tržnici, kiosk) ali / <i>object at a permanent location (e.g. market stand, newsstand) or</i> C – posamezna elektronska naprava za izdajo računov ali vezana knjiga računov v primerih, ko zavezanec ne uporablja drugega poslovnega prostora / <i>individual electronic device for issuing invoices or pre-numbered invoice book in cases when the person liable doesn't</i>	Da, če zavezanec izdaja račune v premičnem poslovnem prostoru / <i>Yes if the person liable issues invoices in movable business premises</i>	<i>Text</i>	<i>Min1, Max1</i>	<i>BusinessPremiseRequest/BusinessPremise/BPIDentifier/PremiseType</i>

		<i>use other business premises</i>				
P_6.0	+ Datum začetka veljavnosti podatkov / <i>Date when data become valid</i>	Datum začetka veljavnosti podatkov o poslovnem prostoru, ki se posredujejo. / <i>The date when data about business premises, which are submitted, become valid.</i> Podatek se vpiše v obliki: LLLL-MM-DD / <i>The data is entered in the following form: YYYY-MM-DD</i>	DA / <i>YES</i>	<i>Date</i>		<i>BusinessPremiseRequest/BusinessPremise/ValidityDate</i>
P_7.0	+ Zaprtje poslovnega prostora / <i>Closure of business premises</i>	Vpiše se podatek o zaprtju poslovnega prostora, če gre za trajno zaprtje. / <i>The data is entered about the closure of business premises if the closure is permanent.</i> Možna je vrednost »Z«. / <i>The possible value is »Z«.</i> Po zaprtju v tem poslovnem prostoru ni več možno izdajati računov in računov z oznako tega poslovnega prostora ni več možno posredovati davčnemu organu. / <i>After closure issuing invoices is not possible anymore in these business premises and it is not possible to submit invoices to the tax authority with the mark of these business premises.</i>	Da, v primeru zaprtja / <i>Yes in cases of closure</i>	<i>Text</i>	<i>Min1, Max1</i>	<i>BusinessPremiseRequest/BusinessPremise/ClosingTag</i>
P_8.0	+ Proizvajalec ali vzdrževalec programske opreme / <i>Producer or software maintenance provider</i>	Vpiše se podatek o proizvajalcu ali vzdrževalcu programske opreme za izdajanje računov. / <i>The data is entered about the producer or software maintenance provider for issuing invoices.</i>  Vpiše se eden od podatkov / <i>One of the following data is entered:</i> – Davčna številka pravne ali fizične osebe - proizvajalca ali vzdrževalca programske opreme s sedežem v Sloveniji in / <i>tax number of a legal</i>	DA / <i>YES</i>			<i>BusinessPremiseRequest/BusinessPremise/SoftwareSupplier/</i>

		<p><i>entity or an individual – producer or software maintenance provider established in Slovenia and</i></p> <p><i>– naziv in naslov proizvajalca ali vzdrževalca programske opreme, ki nima sedeža v Sloveniji / title and address of the producer or software maintenance provider not established in Slovenia</i></p>				
P_8.1	++ Davčna številka proizvajalca ali vzdrževalca programske opreme / <i>Tax number of the producer or software maintenance provider</i>	Vpiše se davčna številka pravne ali fizične osebe – proizvajalca ali vzdrževalca programske opreme s sedežem v Sloveniji. / <i>The tax number is entered of a legal entity or an individual – producer or software maintenance provider established in Slovenia.</i>	DA, če ima proizvajalec ali vzdrževalec sedež v Sloveniji / <i>YES if the producer or software maintenance provider is established in Slovenia</i>	<i>Text</i>	<i>Min8, Max8</i>	<i>BusinessPremiseRequest/BusinessPremise/SoftwareSupplier/TaxNumber</i>
P_8.2	++ Naziv in naslov proizvajalca ali vzdrževalca programske opreme / <i>Title and address of the producer or software maintenance provider</i>	Vpiše se naziv in naslov proizvajalca ali vzdrževalca programske opreme, ki nima sedeža v Sloveniji. / <i>The title and address is entered of the producer or software maintenance provider not established in Slovenia.</i>	DA, če proizvajalec ali vzdrževalec nima sedeža v Sloveniji / <i>YES if the producer or software maintenance provider is not established in Slovenia</i>	<i>Text</i>	<i>Min1, Max1000</i>	<i>BusinessPremiseRequest/BusinessPremise/SoftwareSupplier/NameForeign</i>
P_9.0	+ Ostalo / <i>Other</i>	Vpišejo se morebitne druge oznake, ki podrobneje pojasnjujejo zapise v zvezi z vsebino podatkov o poslovnem prostoru. / <i>Any other potential marks are entered, which explain in detail the records in connection with the content of data about business premises.</i>	NE / <i>NO</i>	<i>Text</i>	<i>Min1, Max1000</i>	<i>BusinessPremiseRequest/BusinessPremise/SpecialNotes</i>

### 3.2.2. SHEMA SPOROČILA TIPA POSLOVNI PROSTOR / SCHEMA OF THE MESSAGE OF THE BUSINESS PREMISES TYPE

Sledeča slika prikazuje shemo sporočila s podatki o poslovnem prostoru. / The following picture presents the schema of the message with data about business premises.

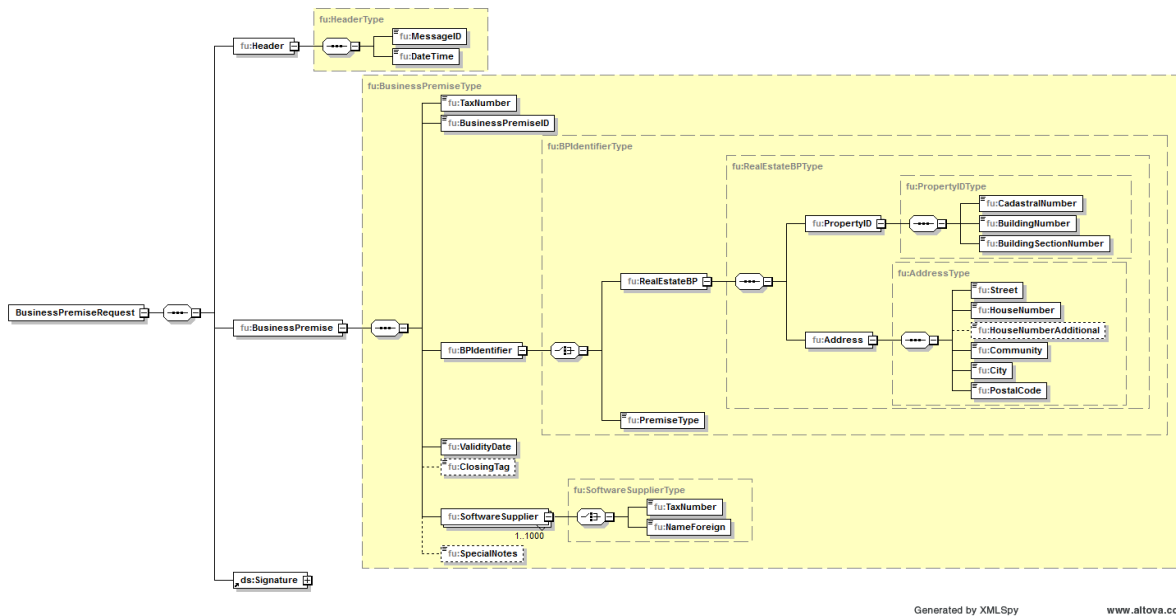

Generated by XMLSpy

www.altova.com

### 3.2.3. PRIMER SPOROČILA TIPA POSLOVNI PROSTOR / EXAMPLE OF THE MESSAGE OF THE BUSINESS PREMISES TYPE

Spodnji primer sporočila s podatki o poslovnem prostoru vsebuje podatke, ki so testni in niso nujno vsebinsko pravilni. / *The example below of the message with data about business premise includes test data, which are not necessarily substantively accurate.* Primer prijave poslovnega prostora / *example for business premises' reporting*

```
<?xml version="1.0" encoding="UTF-8"?><soapenv:Envelope
xmlns:soapenv="http://schemas.xmlsoap.org/soap/envelope/" xmlns:fu="http://www.fu.gov.si/"
xmlns:xd="http://www.w3.org/2000/09/xmldsig#">
  <soapenv:Body>
    <fu:BusinessPremiseRequest Id="data">
      <fu:Header>
        <fu:MessageID>4e64a93a-40fa-4c02-afb1-488534b85e4c</fu:MessageID>
        <fu:DateTime>2015-07-17T09:30:47Z</fu:DateTime>
      </fu:Header>
      <fu:BusinessPremise>
        <fu:TaxNumber>99999862</fu:TaxNumber>
        <fu:BusinessPremiseID>36CF</fu:BusinessPremiseID>
        <fu:BPIIdentifier>
          <fu:RealEstateBP>
            <fu:PropertyID>
              <fu:CadastralNumber>365</fu:CadastralNumber>
              <fu:BuildingNumber>12</fu:BuildingNumber>
              <fu:BuildingSectionNumber>3</fu:BuildingSectionNumber>
            </fu:PropertyID>
            <fu:Address>
              <fu:Street>Dunajska cesta</fu:Street>
              <fu:HouseNumber>24</fu:HouseNumber>
              <fu:HouseNumberAdditional>B</fu:HouseNumberAdditional>
              <fu:Community>Ljubljana</fu:Community>
              <fu:City>Ljubljana</fu:City>
              <fu:PostalCode>1000</fu:PostalCode>
            </fu:Address>
          </fu:RealEstateBP>
        </fu:BPIIdentifier>
        <fu:ValidityDate>1990-08-25</fu:ValidityDate>
        <fu:ClosingTag>Z</fu:ClosingTag>
        <fu:SoftwareSupplier>
          <fu:TaxNumber>24564444</fu:TaxNumber>
        </fu:SoftwareSupplier>
        <fu:SpecialNotes>Primer prijave poslovnega prostora</fu:SpecialNotes>
      </fu:BusinessPremise>
    </fu:BusinessPremiseRequest>
  </soapenv:Body>
</soapenv:Envelope>
```



### 3.2.4. VSEBINA IN OBLIKA ODGOVORA NA SPOROČILO TIPA POSLOVNI PROSTOR / CONTENT AND FORM OF THE RESPONSE TO THE MESSAGE OF THE BUSINESS PREMISES TYPE

Nabor podatkov za odgovor na sporočilo tipa poslovni prostor. / *Set of data for the response to the message of the business premises type*

Ime elementa / Name of the element	Uporaba/opis elementa / <i>Usage/description of the element</i>	Obvezen podatek / Obligatory data  DA/NE / YES/NO	Tip podatka / <i>Data type</i>	Zaloga vrednosti / Stock of values
+ Glava sporočila / <i>Message header</i>				
++ Identifikator sporočila / <i>Message identifier</i>	Identifikator sporočila iz sporočila tipa poslovni prostor. / <i>Message identifier from the message of the business premises type</i>	DA / YES	<i>Text</i>	<i>Min36, Max 36</i>
++ Datum in čas pošiljanja / <i>Date and time of sending</i>	Datum in čas pošiljanja sporočila. / <i>Date and time of sending the message</i>  LLLL-MM-DDTUU:MM:SS /  YYYY-MM-DDTHH:MM:SS	DA / YES	<i>Date Time</i>	
+ Napake / <i>Errors</i>		NE / NO		
++Šifrant napake / <i>Error code table</i>	Napaka je opisana s formatom sXXX, kjer je XXX tri znakovna števka. / <i>The error is described with sXXX format where XXX is a three-character digit.</i>	NE / NO		
++Opis napake / <i>Error description</i>	Opisna napaka. / <i>Description error</i>	NE / NO		

### 3.2.5. SHEMA ODGOVORA NA SPOROČILO TIPA POSLOVNI PROSTOR / SCHEMA OF THE RESPONSE TO THE MESSAGE OF THE BUSINESS PREMISES TYPE

Sledeča slika prikazuje shemo odgovora na sporočilo s podatki o poslovnem prostoru. / *The following picture presents the schema of the response to the message with data about business premises.*

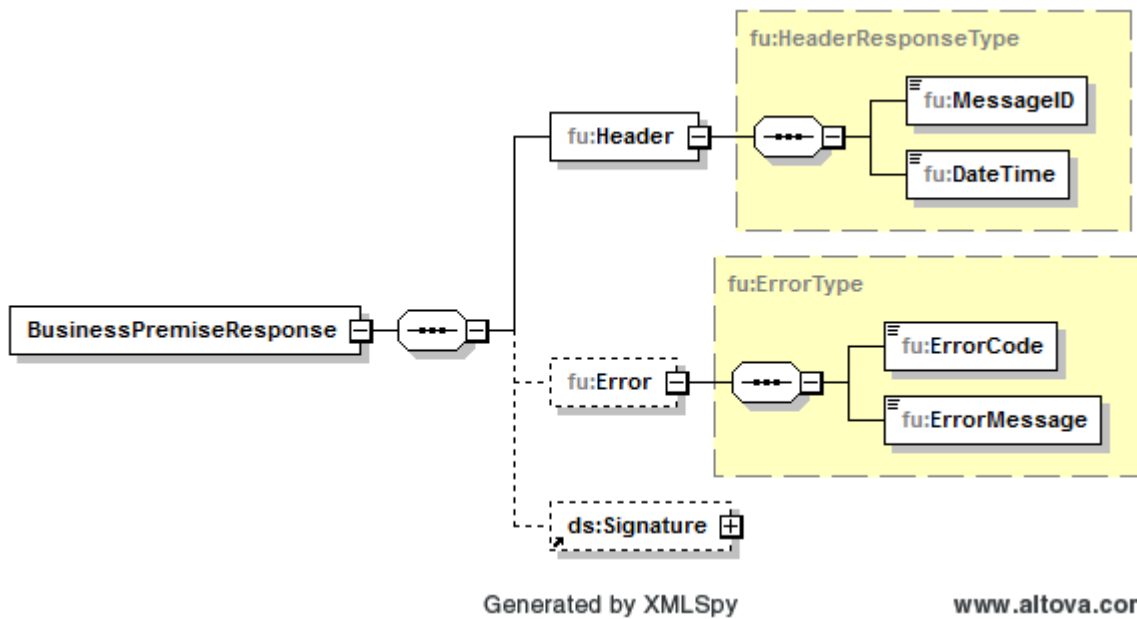

### 3.2.6. PRIMER ODGOVORA NA SPOROČILO TIPA POSLOVNI PROSTOR / EXAMPLE OF THE RESPONSE TO THE MESSAGE OF THE BUSINESS PREMISES TYPE

Spodnji primer odgovora na sporočilo s podatki o poslovnem prostoru vsebuje podatke, ki so testni in niso nujno vsebinsko pravilni. / *The example below of the response to the message with data about business premises includes test data, which are not necessarily substantively accurate.*

Primer brez napake / *Example without an error:*

```
<fu:BusinessPremiseResponse Id="data">
  <fu:Header>
    <fu:MessageID>4e64a93a-40fa-4c02-afb1-488534b85e4c</fu:MessageID>
    <fu:DateTime>2015-08-25T12:03:33.449Z</fu:DateTime>
  </fu:Header>
</fu:BusinessPremiseResponse>
```

Primer z napako / *Example with an error:*

Sporočilo ni v skladu z XML shemo / *Message is not in compliance with XML schema*

```
<fu:BusinessPremiseResponse Id="data">
  <fu:Header>
    <fu:MessageID>4e64a93a-40fa-4c02-afb1-488534b85e4c</fu:MessageID>
    <fu:DateTime>2015-08-25T12:03:33.449Z</fu:DateTime>
  </fu:Header>
  <fu>Error>
    <fu:ErrorCode>s001</fu:ErrorCode>
    <fu:ErrorMessage>Sporočilo ni v skladu z XML shemo.</fu:ErrorMessage>
  </fu>Error>
</fu:BusinessPremiseResponse>
```

### 3.3. SPOROČILO TIPA »ECHO« / MESSAGE OF THE ECHO TYPE

Spodnji diagram opisuje proces tipa »echo«. / The diagram below describes the process of the echo type.

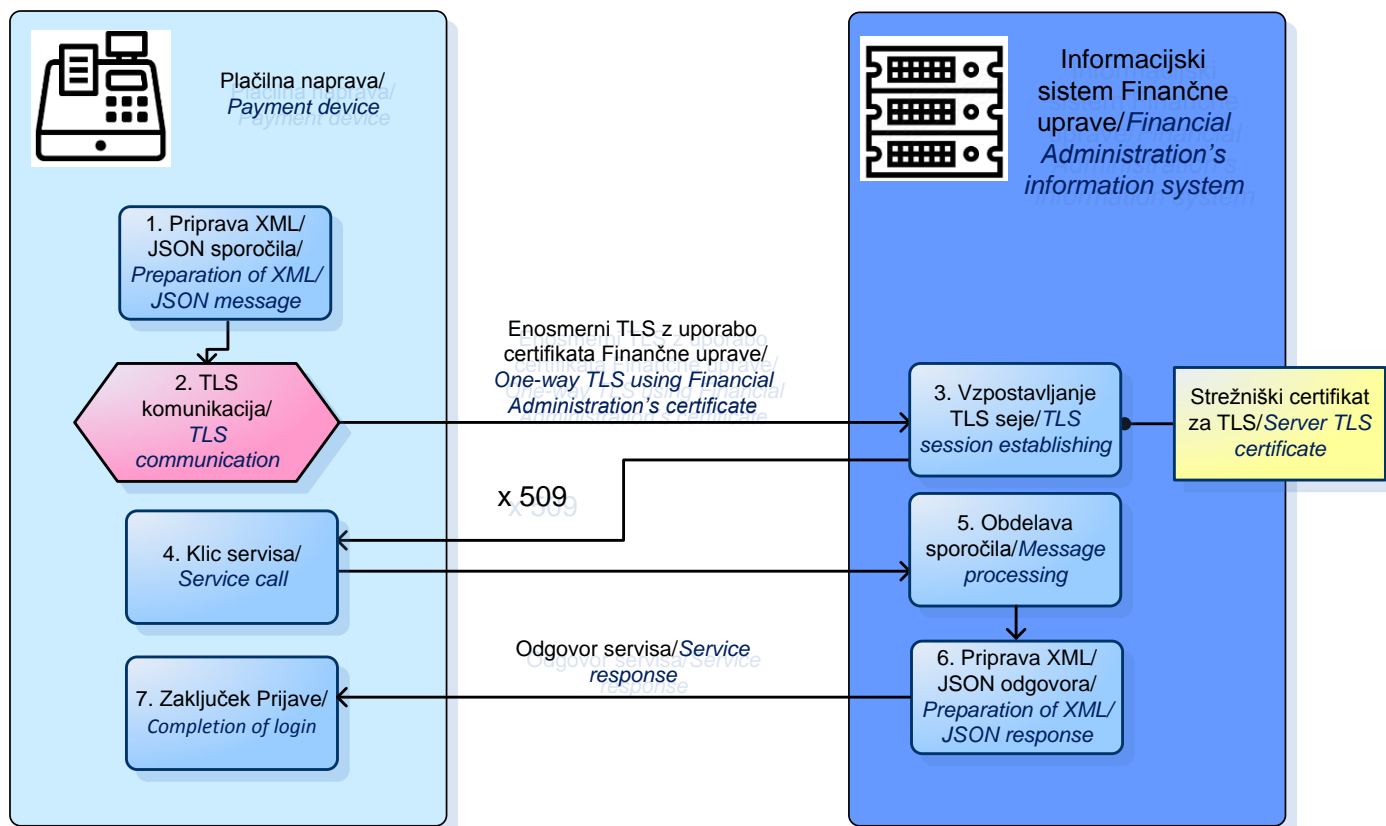

#### 3.3.1. PRIMER SPOROČILA TIPA »ECHO« / EXAMPLE OF THE ECHO TYPE MESSAGE

```
<soapenv:Envelope xmlns:soapenv="http://schemas.xmlsoap.org/soap/envelope/" xmlns:fu="http://www.fu.gov.si/"
xmlns:xd="http://www.w3.org/2000/09/xmldsig#">
  <soapenv:Body>
    <fu:EchoRequest>test</fu:EchoRequest>
  </soapenv:Body>
</soapenv:Envelope>
```

#### 3.3.2. PRIMER ODGOVORA NA SPOROČILO TIPA »ECHO« / EXAMPLE OF THE RESPONSE TO THE ECHO TYPE MESSAGE

```
<soapenv:Envelope xmlns:soapenv="http://schemas.xmlsoap.org/soap/envelope/"
xmlns:xsd="http://www.w3.org/2001/XMLSchema" xmlns:fu="http://www.fu.gov.si/"
xmlns:ds="http://www.w3.org/2000/09/xmldsig#" xmlns:xsi="http://www.w3.org/2001/XMLSchema-instance">
  <soapenv:Body>
    <fu:EchoResponse>test</fu:EchoResponse>
  </soapenv:Body>
</soapenv:Envelope>
```

## 4. ŠIFRANT NAPAK / ERROR CODE TABLE

Šifra napake / <i>Error code</i>	Opis napake / <i>Error description</i>	Opomba / <i>Note</i>
S001	Sporočilo ni v skladu s shemo XML / <i>Message is not in compliance with XML schema</i>	
S002	Sporočilo ni v skladu s shemo JSON / <i>Message is not in compliance with JSON schema</i>	
S003	Digitalni podpis ni ustrezen / <i>Digital signature is not appropriate</i>	
S004	Identifikator digitalnega potrdila ni ustrezen / <i>Digital certificate identifier is not appropriate</i>	Za podano serijsko številko digitalnega potrdila ne obstaja digitalno potrdilo v ISFU / <i>There is no digital certificate in ISFU for the submitted serial number of the digital certificate</i>
S005	Davčna številka v sporočilu ni enaka davčni številki iz digitalnega potrdila / <i>Tax number in the message is not the same as the tax number from the digital certificate</i>	
S006	Podatki o poslovnem prostoru niso posredovani / <i>Data about business premises are not submitted</i>	Preverja se vrednost v elementu / <i>The value is checked in the element &lt;fu:BusinessPremiseID&gt; . Naveden poslovni prostor je potrebno predhodno prijaviti s pošiljanjem sporočila tipa poslovni prostor. / <i>It is necessary to report the stated business premises first with sending the message of the business premises type. Poslovni prostor ne sme biti označen kot zaprt / Business premises shall not be marked as closed (fu:ClosingTag = »Z«)</i></i>
S007	Digitalno potrdilo je preklicano / <i>Digital certificate is withdrawn</i>	
S008	Digitalnemu potrdilu je potekla veljavnost / <i>The validity of the digital certificate is expired</i>	
S100	Sistemska napaka pri obdelavi	

	sporočila / <i>System error at processing of the message</i>	
--	--	--

## 5. ELEKTRONSKI PODPIS SPOROČIL V XML OBLIKI / ELECTRONIC SIGNATURE OF MESSAGES IN XML FORM

Sporočila je potrebno podpisati, da zagotovimo nespremenjenost vsebine. Za podpis XML-ja se uporablja način podpisovanja »XML enveloped signature«. Podpis se nahaja znotraj podpisanega elementa. /  
*Signatures shall be signed to provide for the unchanged content. »XML enveloped signature« is used for signing XML. The signature is located within the signed element.*

Podpis je definiran s shemo / *The signature is defined with the schema <http://www.w3.org/TR/2002/REC-xmldsig-core-20020212/xmldsig-core-schema.xsd>*

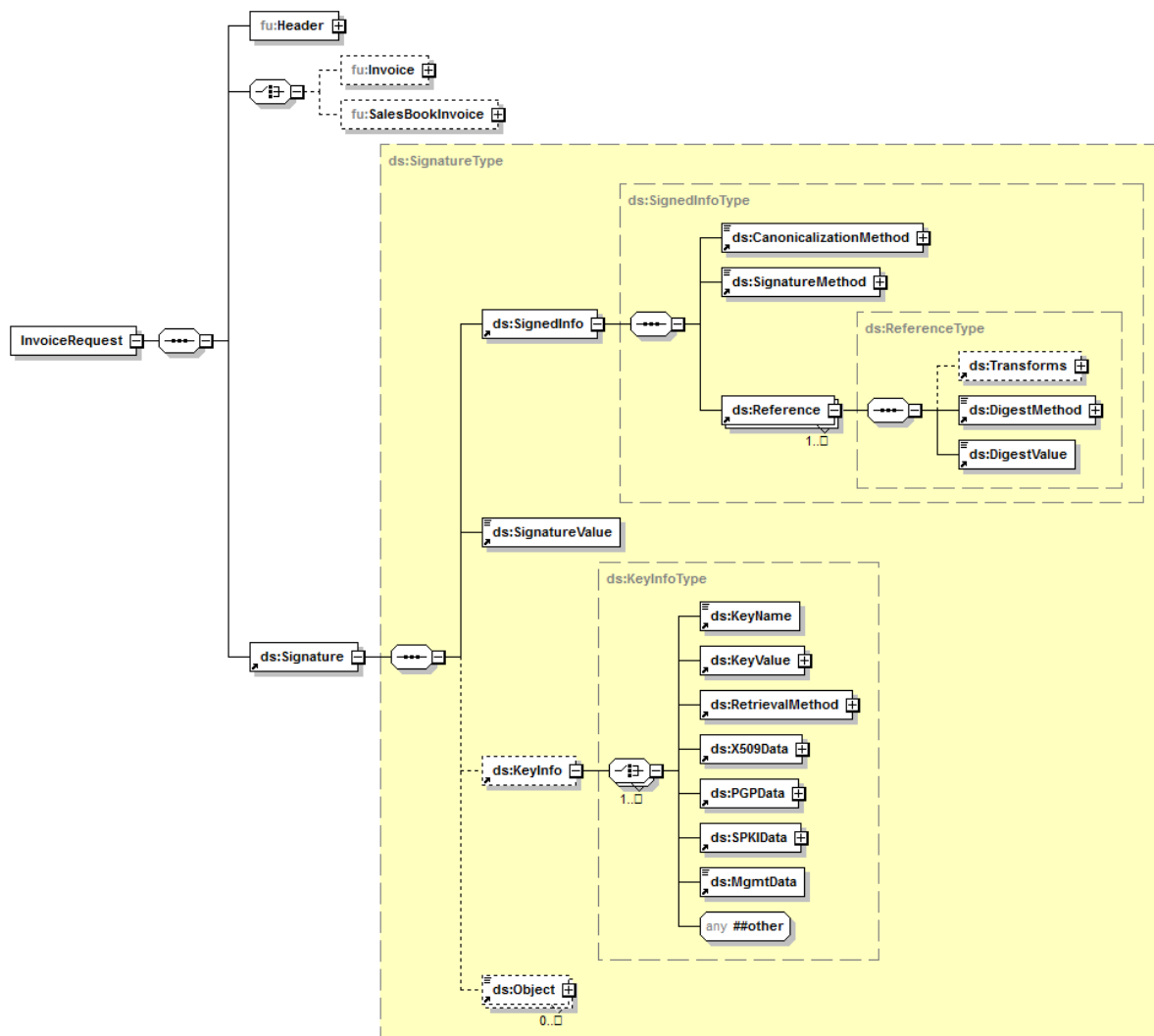

Generated by XMLSpy

www.altova.com

Primer podpisa s testnim certifikatom / *Example of the signature with the test certificate:*

```
<?xml version="1.0" encoding="UTF-8"?>
<soapenv:Envelope xmlns:soapenv="http://schemas.xmlsoap.org/soap/envelope/" xmlns:fu="http://www.fu.gov.si/"
xmlns:xd="http://www.w3.org/2000/09/xmldsig#" xmlns:xsi="http://www.w3.org/2001/XMLSchema-instance">
  <soapenv:Header />
  <soapenv:Body>
    <fu:InvoiceRequest Id="test">
      <fu:Header>
        <fu:MessageID>4e64a93a-40fa-4c02-afb1-488534b85e4c</fu:MessageID>
        <fu:DateTime>2015-08-07T13:05:24</fu:DateTime>
      </fu:Header>
      <fu:Invoice>
        ...
      </fu:Invoice>
      <Signature xmlns="http://www.w3.org/2000/09/xmldsig#"><SignedInfo>
<CanonicalizationMethod Algorithm="http://www.w3.org/TR/2001/REC-xml-c14n-20010315" />
<SignatureMethod Algorithm="http://www.w3.org/2001/04/xmldsig-more#rsa-sha256" />
<Reference URI="#test"><Transforms>
<Transform Algorithm="http://www.w3.org/2000/09/xmldsig#enveloped-signature" /></Transforms>
<DigestMethod Algorithm="http://www.w3.org/2001/04/xmlenc#sha256" />
<DigestValue>H+6rPvK6ekMSDKNEzwxoD5ewA0br2owR+1rFUrzIBE=</DigestValue>
</Reference>
</SignedInfo>
<SignatureValue>QCZyHtQI3PF7sFS0/vlbaHy1kNUr7B/SII6eqT9sUznm8Zm7xGu88J+Kvqei7IC/YhxIXoLPVay7Y+9d
PM729GPaldETkWEZaiPXhHluWT/0VfPohFW7qet5Ar4N2uvtkYgztI0tjABI3jPacrdjgqERbljc/bF3q8dEOHqcKn/i6TVor
ObDEXnA0ZmAdmr4Q11f3nXo7P6dDaLmZzhvMNGniHN/B+NmAaZcb2d/NmQnSCn1GB58y42rgka/LoltL0iN9gqyRgn
oV4QXLkKj7tRsXTMywmZqKaa5F8Vllx6mvgw5rhkBSVU5Qnu+2qg6v0kfr46Tpm7vlodR8YkTsw==</SignatureValue
>
<KeyInfo>
<X509Data>
<X509IssuerSerial>
<X509IssuerName>CN=Tax CA Test, O=state-institutions, C=SI</X509IssuerName>
<X509SerialNumber>2575988469811686647</X509SerialNumber>
</X509IssuerSerial>
<X509SubjectName>CN="ITM STORITVE, ŠPELA PERGAR S.P.", SERIALNUMBER=1, OU=99999862,
OU=DavPotRacTEST, O=state-institutions, C=SI</X509SubjectName>
</X509Data>
</KeyInfo>
</Signature>
</fu:InvoiceRequest>
  </soapenv:Body>
</soapenv:Envelope>
```

Posebnosti / *Special characteristics:*

1. Podpisu zahteve ni potrebno pripenjati X509 certifikata. Podatke o javnem ključu certifikata zavezanca bo imel ISFU shranjen lokalno. / *X509 certificate doesn't have to be attached to the signature of the request. ISFU will have data about the public key of the certificate of the person liable stored locally.*
2. Obvezni elementi znotraj elementa / *Obligatory elements within the element* <KeyInfo><X509Data> v podpisu so / *in the signature are* X509SubjectName, X509IssuerName, X509SerialNumber (desetiški zapis / *decimal notation*).

Znotraj elementa SignedInfo so definirani podatki o kanonizaciji in metodi podpisovanja. Metoda za kanonizacijo XML vsebine je (INCLUSIVE) / *Within the SignedInfo element data are defined about canonicalization and method for signing. The method for canonicalization of XML content is (INCLUSIVE):*

<CanonicalizationMethod Algorithm="http://www.w3.org/TR/2001/REC-xml-c14n-20010315"/>

Metoda podpisovanja je SHA256 / *SHA256 is the signature method:*

<SignatureMethod Algorithm="http://www.w3.org/2001/04/xmldsig-more#rsa-sha256"/>

Element <Reference> ima atribut URI, ki se mora ujemati z »Id« atributom root elementa (definirano v shemi). / <Reference> *element has URI attribute, which shall comply with »Id« attribute of root element (defined in the schema).*

Metoda zgoščevanja je SHA256 / *SHA256 is the digest method:*

<DigestMethod Algorithm="http://www.w3.org/2001/04/xmlenc#sha256" />

V odgovoru se vrne tudi element X509Certifikat in public key / *In the response X509Certificate and public key also return:*

```
<?xml version="1.0" encoding="UTF-8"?>
<soapenv:Envelope xmlns:soapenv="http://schemas.xmlsoap.org/soap/envelope/"
xmlns:xsd="http://www.w3.org/2001/XMLSchema" xmlns:fu="http://www.fu.gov.si/"
xmlns:xsi="http://www.w3.org/2001/XMLSchema-instance">
  <soapenv:Body>
    <fu:InvoiceResponse Id="data">
      <fu:Header>
        <fu:DateTime>2015-08-07T13:06:52.631Z</fu:DateTime>
        <fu:MessageID>4e64a93a-40fa-4c02-afb1-488534b85e4c</fu:MessageID>
      </fu:Header>
      <fu:UniqueInvoiceID>b5f1c310-3dea-4331-82f8-d2dc72d9d018</fu:UniqueInvoiceID>
      <Signature xmlns="http://www.w3.org/2000/09/xmldsig#">
        <SignedInfo>
          <CanonicalizationMethod Algorithm="http://www.w3.org/TR/2001/REC-xml-c14n-20010315"/>
          <SignatureMethod Algorithm="http://www.w3.org/2001/04/xmldsig-more#rsa-sha256"/>
          <Reference URI="#data">
            <Transforms>
              <Transform Algorithm="http://www.w3.org/2000/09/xmldsig#enveloped-signature"/>
            </Transforms>
            <DigestMethod Algorithm="http://www.w3.org/2001/04/xmlenc#sha256"/>
            <DigestValue>I6q1hox5TosjTD+JzyMw+lihN/FOn337peonQS+LixU=</DigestValue>
          </Reference>
        </SignedInfo>
        <SignatureValue>DDZKkEKxcP446Esyhk+TBkWurQd4QLhSvfhvyepPccLgTYcRN7aibDbMcb74MWbqtZ1M1TQaVo
NpM3dXvOkp2HwluFakR4R2PbwSu6kYxOFXIMjppqSRbSoyspSbx2d4jDozo/oD9WFFA5qDWwC1c/A3GXiamv4L4pm
L0BPc7LWh+qZDF8ACI+7oOKnVBKwKahY64UP3ssrUtQihQ+vXPYv/bH7uNLfpd06G5Edpt5hqofLmcZG3bt nukBpER
RuASrNHxN9khyxmdG1wnO0dpdy9jRX5ZpXT8YIyXRYEDEks8L6jgZQopw3k+vVah3QU3a3mmpP91iYDs5JuLn/biu0A
==</SignatureValue>
      <KeyInfo>
        <X509Data>
          <X509SubjectName>CN=FURS,2.5.4.5=#130131,OU=77695771,OU=DavPotRacTEST,O=state-
institutions,C=SI</X509SubjectName>
          <X509IssuerSerial>
            <X509IssuerName>CN=Tax CA Test,O=state-institutions,C=SI</X509IssuerName>
            <X509SerialNumber>4723074879886330622</X509SerialNumber>
          </X509IssuerSerial>
          <X509Certificate>MIIFXjCCA0agAwIBAgIIQYU7IE8yCv4wDQYJKoZIhvcNAQELBQAwQDELMAkGA1UEBhMCU0kxG
aZBgbNVBAoMEEnN0YXRILWluc3RpdHV0aW9uczEUMBIGA1UEAwwLVGF4IENBIFRlc3QwHhcNMjUwODM0MTUwODMx

```



MjQ3WhcNMjAwODA0MTMxMjQ3WjBwMQswCQYDVQQGEwJTSTEBMBkGA1UECgwSc3RhdGUtaW5zdGI0dXRpb25zMRYwFAyDVQQLDA1EYXZQb3RSYWNURVNUMREwDwYDVQQLDAg3NzY5NTc3MTEKMAgGA1UEBRMBMTENMAsGA1UEAwwERIVSUzCCASlWdQYJKoZIhvcNAQEBBQADggEPADCCAQoCggEBAIf8jVOE1Je+Jqbs+I+LMK3/OUJ/Zj1GbAfdWst/grzKKEh93oeIACEvqrJuOZy0qb05NWJ0ra8J4a7Dg4L4UM7Hzc9Os8TgkT5A7Dh85wlAXgOKk4GDi6IHliHmaHlaq0ymP2KAvTo3yenmWVclniQYgbiDgXbHLtMfHphqtXdh38rFhFESE8m453mLtzNUOBD7JQbRZ2k5XcJtoFOXdwUlwif9KzRm/u7E3TqEVvuVQ7kucli5zHoDC6EiF6i/BqAUcNuNyMTBTFixSZnUjOiWgij+DOvFHw36cu4ItrWeXL8JHIZy8gvxGNMPJFk4/Ei090GeMgIUxFtVtiKwGUCAwEAAaOCASowggEmMHAGCCsGAQUFBwEBBGQwYjA0BggrBgEFBQcwAoYoaHR0cDovL2NhLXRlc3QuZ292LnNpL2NlcnQvVGF4Q0FUZXN0LmNydDAqBggrBgEFBQcwAYYYeaHR0cDovL29jc3AtdGF4Y2EtdGVzdC5nb3Yuc2kvMB0GA1UdDgQWBQBQUVWSPgf2GcmPAg/v/uYMBIFC+yDAMBGNVHRMBAf8EAjAAMB8GA1UdIwQYMBaAFDPNWvsJR8cB5jYoJvWBfLeONfeyMBoGA1UdIAQTMBEwDwYnKwYBBAGChG+PXwcVATA4BgNVHR8EMTAvmc2gK6AphidodHRwOi8vY2EtdGVzdC5nb3Yuc2kvY3JsL1RheENBVGZzdC5jcmwwDgYDVROPAQH/BAQDAgeAMA0GCSqGSIb3DQEBCwUAA4ICAQBBDONBas74WUY8JSO00/zlSrk2xWHIB7jpQsyfyAGrfYUwma684eWuBqEfpOBx1FimYyT2iURFmWGApXTNfBN6rZyY0LHW6R5N/g0bifsRJZgZBh+SijguOtl+yujeNBqmAikwpfSUxSyQwuGGow29LC2n/f5kPaM5cRiXAZx3jR0xTAAHYNjc2//+j8xBU5foA8Z2YG/utl3mqy//FAt d1TKmpUmCdMKQ1A7jZIGz8FdB38TPg8OAUfnVQPgGxJJ3sMpk7JXRPRGHHenIRfnOXyukLa62TsG+JTaj+HEUIEAPI5Gm0usWDsaSZ7oGyD0dPngSEvIT3/8KbYge4bxE0Eb20dnz6/6/HZo4gBqT3OZMCu3rzBUlae+/1ALDhGnqOUZEYgAljKqgUn/o5K0QrWCHysusmTgefJHNxXPXQgkL0KocjkNoojSnidaiLW35XoB7QKWObjK8EgJvsHir18f82e3AP3tJkBgHu3UD0y/A20Nb4fujWcE337dAHwsVA+DPujN8lanDDNhRnFPutiuc4Y6GMnHSplfJBqDhtUTNmucrnIT/R0KbPDDs6q/DDICyYnxtgdypwVDkNHIEYr8U+Q1yIWxsqKp6Kk6/NkAKiiXhFz+XHZx+vaKZ90F7yW+dV5F/zALaXLfUw2Z1m axmQFit7S47Usm2e/Hfgg==</X509Certificate>

</X509Data>

<KeyValue>

<RSAKeyValue>

<Modulus>h/yNU4TUI74mpuz4j4swrf85Qn9mPUZsB91ay3+CvMooSH3eh4gAIS+qsm45nLSpvTk1YnStrwnhrsOAvhQzsfNz06zxOCRPKDsOHznCUBeA4qTgYOLqUeWleZoeVqrTKY/YoC9OjfJ6eZZVwieJBiBvOIMZdscu0x8emG2pcOHfysWEURITybjneYu3M1Q4EPsIBtFnaTldwm2gU5d3BQjCJ/0rNGb+7sTdOoRW+5VDuS5yWLnMegMLoSIXqL8GoBRw241iZMFMWwXFJmdSM6JaCKP4M68UfDfpy7gi2tZ5cvwkchnLyC/EY0w8kWTj8SLT04Z4yCUhTEW1W2lrAZQ==</Modulus>

<Exponent>AQAB</Exponent>

</RSAKeyValue>

</KeyValue>

</KeyInfo>

</Signature>

</fu:InvoiceResponse>

</soapenv:Body>

</soapenv:Envelope>

## 6. POSTOPEK POVEZOVANJA ZAVEZANCEV NA IS FINANČNE UPRAVE / PROCEDURE FOR CONNECTING PERSONS LIABLE WITH THE INFORMATION SYSTEM OF THE FINANCIAL ADMINISTRATION

1. Zavezanec mora pridobiti vsaj eno namensko digitalno potrdilo - testno ali produkcijsko (glede na okolje na katero se ima namen povezati). O številu potrebnih digitalnih potrdil se odloča zavezanec samostojne glede na svoje potrebe. Postopek pridobivanja digitalnih potrdil je opisan v poglavju 2. / *Persons liable shall acquire at least one digital certificate for invoice fiscal verification purposes – test or production (in connection with the environment, to which they intend to connect). Persons liable decide about the number of necessary digital certificates independently on the basis of their needs. The procedure for acquiring digital certificates is described in Chapter 2.*
2. Po prevzemu digitalnih potrdil jih zavezanec namesti na svoje okolje. / *After accepting digital certificates persons liable install them into their environments.*
3. Zavezanec prevzame digitalna potrdila/javne ključe ISFU za produkcijsko oziroma testno okolje. / *Persons liable accept digital certificates/public keys of ISFU for production/test environment.*
4. Priporočamo, da šele po minimalno dveh dnevih neprekinjenega in stabilnega delovanja v testnem okolju preide zavezanec na produkcijsko okolje. / *We recommend persons liable to transfer to the production environment only after at least two days of uninterrupted and stable working in the test environment.*

### 6.1. NASLOVI ZA POVEZOVANJE NA IS FINANČNE UPRAVE / ADDRESSES FOR CONNECTING TO THE INFORMATION SYSTEM OF THE FINANCIAL ADMINISTRATION

#### 1. TEST

<b>Okolje / Environment:</b>	TEST
<b>Servis / Service:</b>	Sprejem podatkov o računih / <i>Accepting data about invoices</i>
<b>URL (XML):</b>	<a href="https://blagajne-test.fu.gov.si:9002/v1/cash_registers">https://blagajne-test.fu.gov.si:9002/v1/cash_registers</a>
<b>URL (JSON):</b>	<a href="https://blagajne-test.fu.gov.si:9002/v1/cash_registers/invoices">https://blagajne-test.fu.gov.si:9002/v1/cash_registers/invoices</a>

<b>Okolje / Environment:</b>	TEST
<b>Servis / Service:</b>	Sprejem podatkov o poslovnih prostorih / <i>Accepting data about business premises</i>
<b>URL (XML):</b>	<a href="https://blagajne-test.fu.gov.si:9002/v1/cash_registers">https://blagajne-test.fu.gov.si:9002/v1/cash_registers</a>
<b>URL (JSON):</b>	<a href="https://blagajne-test.fu.gov.si:9002/v1/cash_registers/invoices/register">https://blagajne-test.fu.gov.si:9002/v1/cash_registers/invoices/register</a>

--	--

<b>Okolje / Environment:</b>	TEST
<b>Servis / Service:</b>	Preverjanje dosegljivosti ISFU (echo) / <i>Checking ISFU availability (echo)</i>
<b>URL (XML):</b>	<a href="https://blagajne-test.fu.gov.si:9002/v1/cash_registers">https://blagajne-test.fu.gov.si:9002/v1/cash_registers</a>
<b>URL (JSON):</b>	<a href="https://blagajne-test.fu.gov.si:9002/v1/cash_registers/echo">https://blagajne-test.fu.gov.si:9002/v1/cash_registers/echo</a>

## 2. PRODUKCIJA / PRODUCTION

<b>Okolje / Environment:</b>	PRODUKCIJA / PRODUCTION
<b>Servis / Service:</b>	Sprejem podatkov o računih in poslovnih prostorih / <i>Accepting data about invoices and business premises</i>
<b>URL (XML):</b>	<a href="https://blagajne.fu.gov.si:9003/v1/cash_registers">https://blagajne.fu.gov.si:9003/v1/cash_registers</a>
<b>URL (JSON):</b>	<a href="https://blagajne.fu.gov.si:9003/v1/cash_registers/invoices">https://blagajne.fu.gov.si:9003/v1/cash_registers/invoices</a>

<b>Okolje / Environment:</b>	PRODUKCIJA / PRODUCTION
<b>Servis / Service:</b>	Sprejem podatkov o poslovnih prostorih / <i>Accepting data about business premises</i>
<b>URL (XML):</b>	<a href="https://blagajne.fu.gov.si:9003/v1/cash_registers">https://blagajne.fu.gov.si:9003/v1/cash_registers</a>
<b>URL (JSON):</b>	<a href="https://blagajne.fu.gov.si:9003/v1/cash_registers/invoices/register">https://blagajne.fu.gov.si:9003/v1/cash_registers/invoices/register</a>

<b>Okolje / Environment:</b>	PRODUKCIJA / PRODUCTION
<b>Servis / Service:</b>	Preverjanje dosegljivosti ISFU (echo) / <i>Checking ISFU availability (echo)</i>
<b>URL (XML):</b>	<a href="https://blagajne.fu.gov.si:9003/v1/cash_registers">https://blagajne.fu.gov.si:9003/v1/cash_registers</a>
<b>URL (JSON):</b>	<a href="https://blagajne.fu.gov.si:9003/v1/cash_registers/echo">https://blagajne.fu.gov.si:9003/v1/cash_registers/echo</a>

Po objavi servisa bo ta stalno dostopen za testiranje v testnem okolju razen v sledečih časovnih intervalih / *After service publishment it will be permanently available for testing in test environment except in the following time intervals:*

- delavniki od 16:00 do 17:00 / *weekdays from 4pm to 5pm*
- nedelje od 08:00 do 12:00 / *Sundays from 8am to 12am*

## 7. PRIMERI SPOROČIL V XML OBLIKI / EXAMPLES OF MESSAGES IN XML FORM

### 7.1. PRIMER RAČUNA V XML OBLIKI S PODPISOM / EXAMPLE OF THE INVOICE IN XML FORM WITH THE SIGNATURE

Primer računa izdanega preko elektronske naprave / *Example of the invoice issued via the electronic device:*

```
<?xml version="1.0" encoding="UTF-8"?>
<soapenv:Envelope xmlns:soapenv="http://schemas.xmlsoap.org/soap/envelope/" xmlns:fu="http://www.fu.gov.si/"
xmlns:xd="http://www.w3.org/2000/09/xmldsig#" xmlns:xsi="http://www.w3.org/2001/XMLSchema-instance">
  <soapenv:Header />
  <soapenv:Body>
    <fu:InvoiceRequest Id="test">
      <fu:Header>
        <fu:MessageID>4e64a93a-40fa-4c02-afb1-488534b85e4c</fu:MessageID>
        <fu:DateTime>2015-08-07T13:05:24</fu:DateTime>
      </fu:Header>
      <fu:Invoice>
        <fu:TaxNumber>99999862</fu:TaxNumber>
        <fu:IssueDateTime>2015-08-07T13:05:24</fu:IssueDateTime>
        <fu:NumberingStructure>B</fu:NumberingStructure>
        <fu:InvoiceIdentifier>
          <fu:BusinessPremiseID>TRGOVINA1</fu:BusinessPremiseID>
          <fu:ElectronicDeviceID>BLAG2</fu:ElectronicDeviceID>
          <fu:InvoiceNumber>145</fu:InvoiceNumber>
        </fu:InvoiceIdentifier>
        <fu:InvoiceAmount>66.71</fu:InvoiceAmount>
        <fu:PaymentAmount>1047.76</fu:PaymentAmount>
        <fu:TaxesPerSeller>
          <fu:VAT>
            <fu:TaxRate>22.00</fu:TaxRate>
            <fu:TaxableAmount>23.14</fu:TaxableAmount>
            <fu:TaxAmount>5.09</fu:TaxAmount>
          </fu:VAT>
          <fu:VAT>
            <fu:TaxRate>9.50</fu:TaxRate>
            <fu:TaxableAmount>35.14</fu:TaxableAmount>
            <fu:TaxAmount>3.34</fu:TaxAmount>
          </fu:VAT>
        </fu:TaxesPerSeller>
        <fu:OperatorTaxNumber>12345678</fu:OperatorTaxNumber>
        <fu:ProtectedID>34905bcff14b381039af2e9d7eee54bb</fu:ProtectedID>
      </fu:Invoice>
      <Signature xmlns="http://www.w3.org/2000/09/xmldsig#"><SignedInfo>
        <CanonicalizationMethod Algorithm="http://www.w3.org/TR/2001/REC-xml-c14n-20010315" />
        <SignatureMethod Algorithm="http://www.w3.org/2001/04/xmldsig-more#rsa-sha256" />
        <Reference URI="#test"><Transforms>
          <Transform Algorithm="http://www.w3.org/2000/09/xmldsig#enveloped-signature" /></Transforms>
          <DigestMethod Algorithm="http://www.w3.org/2001/04/xmlenc#sha256" />
          <DigestValue>H+6rPvK6ekMSDKNEzwxYoD5ewA0br2owR+1rFUzIbE=</DigestValue>
        </Reference>
      </SignedInfo>
```

```

<SignatureValue>QCZyHtQi3PF7sFS0/vIbaHy1kNUr7B/SII6eqT9sUznm8Zm7xGu88J+Kvqei7IC/YhxIXoLPVay7Y+9d
PM729GPaldETkWEZaiPXhHluWT/0VfPohFW7qet5Ar4N2uvTKygztiOjtABI3jPacrdjgqERbljc/bF3q8dEOHqcKn/i6TVor
ObDEXnA0ZmAdmr4Q11f3nXo7P6dDaLmZzhvmNGniHN/B+NmAaZcb2d/NmQnSCn1GB58y42rgka/LoltL0iN9ggyRgn
oV4QXLkKj7tRsXTMywmZqKaa5F8Vllx6mvgw5rhkBSVU5Qnu+2qg6v0kFR46Tpm7vlodR8YkTsw==</SignatureValue
>
<KeyInfo>
<X509Data>
<X509IssuerSerial>
<X509IssuerName>CN=Tax CA Test, O=state-institutions, C=SI</X509IssuerName>
<X509SerialNumber>2575988469811686647</X509SerialNumber>
</X509IssuerSerial>
<X509SubjectName>CN="ITM STORITVE, ŠPELA PERGAR S.P.", SERIALNUMBER=1, OU=99999862,
OU=DavPotRacTEST, O=state-institutions, C=SI</X509SubjectName>
</X509Data>
</KeyInfo>
</Signature>
</fu:InvoiceRequest>
</soapenv:Body>
</soapenv:Envelope>

```

## 7.2. PRIMER ODGOVORA NA RAČUN V XML OBLIKI S PODPISOM / EXAMPLE OF THE RESPONSE TO THE INVOICE IN XML FORM WITH THE SIGNATURE

```

<?xml version="1.0" encoding="UTF-8"?>
<soapenv:Envelope xmlns:soapenv="http://schemas.xmlsoap.org/soap/envelope/"
xmlns:xsd="http://www.w3.org/2001/XMLSchema" xmlns:fu="http://www.fu.gov.si"
xmlns:xsi="http://www.w3.org/2001/XMLSchema-instance">
  <soapenv:Body>
    <fu:InvoiceResponse Id="data">
      <fu:Header>
        <fu:DateTime>2015-08-07T13:06:52.631Z</fu:DateTime>
        <fu:MessageID>4e64a93a-40fa-4c02-afb1-488534b85e4c</fu:MessageID>
      </fu:Header>
      <fu:UniqueInvoiceID>b5f1c310-3dea-4331-82f8-d2dc72d9d018</fu:UniqueInvoiceID>
      <Signature xmlns="http://www.w3.org/2000/09/xmldsig#">
        <SignedInfo>
          <CanonicalizationMethod Algorithm="http://www.w3.org/TR/2001/REC-xml-c14n-20010315"/>
          <SignatureMethod Algorithm="http://www.w3.org/2001/04/xmldsig-more#rsa-sha256"/>
          <Reference URI="#data">
            <Transforms>
              <Transform Algorithm="http://www.w3.org/2000/09/xmldsig#enveloped-signature"/>
            </Transforms>
            <DigestMethod Algorithm="http://www.w3.org/2001/04/xmlenc#sha256"/>
            <DigestValue>l6q1hox5TosjTD+JzyMw+lihN/FOn337peonQS+LixU=</DigestValue>
          </Reference>
        </SignedInfo>
        <SignatureValue>DDZKkEKxcP446Esyhk+TBkWurQd4QLhSVfhvyepPccLgTYcRN7aibDbMcb74MWbqtZ1M1TQaVo
NpM3dXvOkp2HwluFakR4R2PbwSu6kYxOFXIMjppqSRbSoyspSbx2d4jDozo/oD9WFFA5qDWwC1c/A3GXiamv4L4pm
L0BPC7LWh+qZDF8ACI+7oOKnVBKwKahY64UP3ssrUtQihQ+vXPYv/bH7uNLfpd06G5Edpt5hqofLmcZG3btukBpER
RuASrNHxN9khyxmdG1wnO0dpdy9jRX5ZpXT8YlyXRYEDEks8L6jgZQopw3k+vVah3QU3a3mmP91iYDs5JuLn/biu0A
==</SignatureValue>
        <KeyInfo>
          <X509Data>
            <X509SubjectName>CN=FURS,2.5.4.5=#130131,OU=77695771,OU=DavPotRacTEST,O=state-
institutions,C=SI</X509SubjectName>
            <X509IssuerSerial>

```

```

    <X509IssuerName>CN=Tax CA Test,O=state-institutions,C=SI</X509IssuerName>
    <X509SerialNumber>4723074879886330622</X509SerialNumber>
  </X509IssuerSerial>
<X509Certificate>MIIFXJCCA0agAwIBAgIIQYu7IE8yCv4wDQYJKoZIhvcNAQELBQAwQDELMAkGA1UEBhMCU0kxG
zAZBgNVBAoMEEnN0YXRILWluc3RpdHV0aWw5uczEUMBIGA1UEAwwLVGF4IENBIFRlc3QwHhcNMTUwODA0MTMx
MjQ3WWhcNMjAwODA0MTMxMjQ3WjBwMQswCQYDVQQGEWJSTEBMBkGA1UECgwSc3RhdGUtaW5zdGI0dXRpb
25zMRYwFAYDVQQQLDA1EYXZQb3RSYWNUMREwDwYDVQQQLDAg3NzY5NTc3MTEKMAgGA1UEBRMBMT
ENMAAsGA1UEAwwERIVSUzCCASlwDQYJKoZIhvcNAQEBBQADggEPADCCAQoCggEBAlf8jVOE1Je+Jqbs+I+LMK3
/OUJ/Zj1GbAfdWst/grzKKEh93oelACEvqrJuOZy0qb05NWJ0ra8J4a7DgL4UM7Hzc9Os8TgkT5A7Dh85wIAXgOKk4G
Di6IHliHmaHlaq0ymP2KAvTo3yenmWVclniQYgbiDgXbHLTmfHphqtXh38rFhFESE8m453mLtzNUOBD7JQbRZ2k5
XcJtoFOXdwUlWif9KzRm/ue7E3TqEVvuVQ7kucli5zHoDC6EiF6i/BqAUcNuNyMTBTFIxsZnUjOiWgij+DOvFHW36cu4Itr
WeXL8JHIZy8gvxGNMPJFk4/Ei09OGeMgllUxFtVtiKwGUCAwEAAaOCASOwwggEmMHAGCCsGAQUFBwEBBGQwYj
A0BggrBgEFBQcwAoYoaHR0cDovL2NhLXRlc3QuZ292LnNpL2NlcnQvVGF4Q0FUZXN0LmNydDAqBggrBgEFBQcw
AYYeaHR0cDovL29jc3AtdGF4Y2EtdGVzdC5nb3Yuc2kvMB0GA1UdDgQWBQBQUVWSPgf2GcmPAg/v/uYmblFC+yDA
MBgNVHRMBAf8EAjAAMB8GA1UdIwQYMBaAFDPNWvsJR8cB5jYoJvWBfLeONfeyMBoGA1UdIAQTMBEwDwYnK
wYBBAGChG+PXwcVATA4BgNVHR8EMTAvmc2gk6AphidodHRwOi8vY2EtdGVzdC5nb3Yuc2kvY3JsL1RheENBVG
VzdC5jcmwwDgYDVR0PAQH/BAQDAgeAMA0GCSqGSIb3DQEBCwUAA4ICAQBBDONBas74WUY8JSOO0/zlSrk2xW
HIB7jpQsyfyAGrFYUwmA684eWuBuqEfpOBx1FlmYyT2iURFmWGApXTNfBN6rZyY0LHW6R5N/g0bifsRJJZgZBh+SijguO
tl+yujeNBqmAikwpfSUxSyQwUGGOW29LC2n/f5kPaM5cRiXAZx3jkROxTAAHYnjc2//+j8xBU5foA8Z2YG/utl3mqy//FAt
d1TKmpUmCdMKQ1A7jZIGz8FdB38TPg8OAUfnVQPgGxJJ3sMpk7JXRPRGHHenIRfnOXyuKLa62TsG+JTaJ+HEUI
EAPI5Gm0usWDsaSZ7oGyD0dPngSEvIT3/8KbYge4bxEOEb20dnz6/6/HZo4gBqT3OZMCu3rzBUlae+/1ALDhGnqOU
ZEygAljKggUn/o5K0QrWCHysusmTgefJHNxXPXQgkL0KocjNoojSnidaiLW35XoB7QKWObjK8EgJvsHir18f82e3AP3t
JkBgHu3UD0y/A20Nb4fujWcE337dAHwsVA+DPujN8lanDDNhrNfPutiuc4Y6GMnHSpfJBqDHTUTNmucrnIT/R0KbPD
Ds6q/DDICyYnxtgdypwVDkNHIEYr8U+Q1yIWxsqKp6Kk6/NkAKiiXhFz+XHZx+vaKZ90F7yW+dV5F/zALaXLFuwZ21m
axmQFit7S47Usm2e/Hfgg==</X509Certificate>
  <X509Data>
    <KeyValue>
      <RSAKeyValue>
<Modulus>h/yNU4TUI74mpuz4j4swrf85Qn9mPUZsB91ay3+CvMooSH3eh4gAIS+qsm45nLSpvTk1YnStrwnhrsOAvhQ
zsfNz06zxOCRPKDsOHznCUBeA4qTgYOLqUeWleZoeVqrTKY/YoC9OjfJ6eZZVwieJBiBvOIMZdscu0x8emG2pcOHfy
sWEURITybjneYu3M1Q4EPsIBtFnaTldwm2gU5d3BQjCJ/0rNGb+7sTdOoRW+5VDuS5yWLnMegMLoSIXqL8GoBRw
241iZMFMWXFJmdSM6JaCKP4M68UfDfpy7gi2tZ5cvwkchnLyC/EY0w8kWTj8SLT04Z4yCUhTEW1W2lrAZQ==</Mod
ulus>
      <Exponent>AQAB</Exponent>
    </RSAKeyValue>
  </KeyValue>
</KeyInfo>
</Signature>
</fu:InvoiceResponse>
</soapenv:Body>
</soapenv:Envelope>

```

### 7.3. PRIMER PRIJAVE POSLOVNEGA PROSTORA V XML OBLIKI S PODPISOM / EXAMPLE OF REPORTING BUSINESS PREMISES IN XML FORM WITH THE SIGNATURE

```

<?xml version="1.0" encoding="UTF-8"?><soapenv:Envelope
xmlns:soapenv="http://schemas.xmlsoap.org/soap/envelope/" xmlns:fu="http://www.fu.gov.si/"
xmlns:xd="http://www.w3.org/2000/09/xmldsig#">
  <soapenv:Body>
    <fu:BusinessPremiseRequest Id="data">
      <fu:Header>
        <fu:MessageID>4e64a93a-40fa-4c02-afb1-488534b85e4c</fu:MessageID>
        <fu:DateTime>2015-07-17T09:30:47Z</fu:DateTime>
      </fu:Header>
      <fu:BusinessPremise>
        <fu:TaxNumber>99999862</fu:TaxNumber>

```

```

<fu:BusinessPremiseID>36CF</fu:BusinessPremiseID>
<fu:BPIIdentifier>
  <fu:RealEstateBP>
    <fu:PropertyID>
      <fu:CadastralNumber>365</fu:CadastralNumber>
      <fu:BuildingNumber>12</fu:BuildingNumber>
      <fu:BuildingSectionNumber>3</fu:BuildingSectionNumber>
    </fu:PropertyID>
    <fu:Address>
      <fu:Street>Dunajska cesta</fu:Street>
      <fu:HouseNumber>24</fu:HouseNumber>
    <fu:HouseNumberAdditional>B</fu:HouseNumberAdditional>
      <fu:Community>Ljubljana</fu:Community>
      <fu:City>Ljubljana</fu:City>
      <fu:PostalCode>1000</fu:PostalCode>
    </fu:Address>
  </fu:RealEstateBP>
</fu:BPIIdentifier>
<fu:ValidityDate>1990-08-25</fu:ValidityDate>
<fu:ClosingTag>Z</fu:ClosingTag>
<fu:SoftwareSupplier>
  <fu:TaxNumber>24564444</fu:TaxNumber>
</fu:SoftwareSupplier>
<fu:SpecialNotes>Primer prijave poslovnega prostora</fu:SpecialNotes>
</fu:BusinessPremise>
  <Signature xmlns="http://www.w3.org/2000/09/xmldsig#"><SignedInfo><CanonicalizationMethod
Algorithm="http://www.w3.org/TR/2001/REC-xml-c14n-20010315"/><SignatureMethod
Algorithm="http://www.w3.org/2001/04/xmldsig-more#rsa-sha256"/><Reference
URI="#data"><Transforms><Transform Algorithm="http://www.w3.org/2000/09/xmldsig#enveloped-
signature"/></Transforms><DigestMethod
Algorithm="http://www.w3.org/2001/04/xmlenc#sha256"/><DigestValue>daHXxms+SSHE4j6WmvGiAXz/icF8Foeyeu
BC9bl3wE=</DigestValue></Reference></SignedInfo><SignatureValue>Rp3P6hRn4ml1yXa1/kabNMK825O9nKnJIZ
U6ALdkEdwdEEEyJIV1cq0dkwtvvsuEbhUkQjrVVVlj
jUT07vy0zAA2OCrXUfihnQxSXOavkYlk6rzgMCBquEnZuxQabfciRnWAZtbLNF7jQGcGplauuRCd
eh++qQUTvn8L9MaEjor1MRfUELutH1YhzFTv50B5coU311giZRyEk1phP0Qxc/zDobNC2gyvPRvk
SLXPToketSqdSb51tl86hzaLPcresKCDngeEvWHW4Cka0GJvYRF2x2FA1LmwGB3MZb9uuVvKxHiA
RMA0xv1sQ0qCpBFcAZ8KM54wH0br3JpOMHMIYw==</SignatureValue><KeyInfo><X509Data><X509SubjectName
>CN=ITM STORITVE, L PELA PERGAR S.P.,2.5.4.5=#130131,OU=99999862,OU=DavPotRacTEST,O=state-
institutions,C=SI</X509SubjectName><X509IssuerSerial><X509IssuerName>CN=Tax CA Test,O=state-
institutions,C=SI</X509IssuerName><X509SerialNumber>2575988469811686647</X509SerialNumber></X509Issuer
Serial></X509Data></KeyInfo></Signature>
  </fu:BusinessPremiseRequest>
</soapenv:Body>
</soapenv:Envelope>

```

## 7.4. PRIMER ODGOVORA NA PRIJAVO POSLOVNEGA PROSTORA S PODPISOM / EXAMPLE OF THE RESPONSE TO THE REPORT OF BUSINESS PREMISES WITH THE SIGNATURE

```

<?xml version="1.0" encoding="UTF-8"?><soapenv:Envelope
xmlns:soapenv="http://schemas.xmlsoap.org/soap/envelope/" xmlns:xsd="http://www.w3.org/2001/XMLSchema"
xmlns:fu="http://www.fu.gov.si/" xmlns:xsi="http://www.w3.org/2001/XMLSchema-instance">
  <soapenv:Body>
    <fu:BusinessPremiseResponse Id="data">
      <fu:Header>
        <fu:DateTime>2015-08-25T12:04:12.268Z</fu:DateTime>

```







```
VzdC5jcmwwDgYDVR0PAQH/BAQDAgeAMA0GCSqGSIb3DQEBCwUAA4ICAQBBDONBas74WUY8JSOO0/zlSrk2xW
HIB7jpQsyfyAGrfYUwmA684eWuBqEfpOBx1FlmYyT2iURFmwGApXTNfBN6rZyY0LHW6R5N/g0bifsRjZgZBh+SijguO
tl+yujeNBqmAikwfpSUxSyQwuGGOW29LC2n/f5kPaM5cRiXAZx3jkROxTAAHYNjc2//+j8xBU5foA8Z2YG/utl3mqy//FAt
d1TKmpUmCdMKQ1A7jZIGz8FdB38TPg8OAUfnVQPgGxJJ3sMpk7JXRPRGHHenIRfnOXyukLa62TsG+JTaj+HEUI
EAPI5Gm0usWDsaSZ7oGyD0dPngSEvIT3/8KbYge4bxE0Eb20dnz6/6/HZo4gBqT3OZMCu3rzBUlae+/1ALDhGnqOU
ZEYgAljKggqUn/o5K0QrWCHysusmTgefJHNxXPXQgkL0KOcjNoojSnidaiLW35XoB7QKWObjK8EgJvsHir18f82e3AP3t
JkBgHu3UD0y/A20Nb4fujWcE337dAHwsVA+DPujN8lanDDNhRnFPutiuc4Y6GMnHSpfJBqDHTnMucrnIT/R0KbPD
Ds6q/DDICyYnxtgdypwVDkNHIEYr8U+Q1yIWxsqKp6Kk6/NkAKiiXhFz+XHZx+vaKZ90F7yW+dV5F/zALaXLFuw2Z1m
axmQFit7S47Usm2e/Hfgg==</X509Certificate>
```

```
</X509Data>
```

```
<KeyValue>
```

```
<RSAKeyValue>
```

```
<Modulus>h/yNU4TUI74mpuz4j4swrf85Qn9mPUZsB91ay3+CvMooSH3eh4gAIS+qsm45nLSpvTk1YnStrwnhrsOAvhQ
zsfNz06zxOCRPKDsOHznCUBeA4qTgYOLqUeWleZoeVqrTKY/YoC9OjfJ6eZZVwieJBiBoIMZdscu0x8emG2pcOHfy
sWEURITybjneYu3M1Q4EPsIBtFnaTldwm2gU5d3BQjCJ/0rNGb+7sTdOoRW+5VDuS5yWLnMegMLoSIXqL8GoBRw
241iZMFMWXFJmdSM6JaCKP4M68UfDfpy7gi2tZ5cvwkchnLyC/EY0w8kWTj8SLT04Z4yCUhTEW1W2lrAZQ==</Mod
ulus>
```

```
<Exponent>AQAB</Exponent>
```

```
</RSAKeyValue>
```

```
</KeyValue>
```

```
</KeyInfo>
```

```
</Signature>
```

```
</fu:InvoiceResponse>
```

```
</soapenv:Body>
```

```
</soapenv:Envelope>
```

## 7.6. PRIMER ODGOVORA Z NAPAKO IN PODPISOM V XML OBLIKI NA SPOROČILO TIPA POSLOVNI PROSTOR / EXAMPLE OF THE RESPONSE WITH AN ERROR AND SIGNATURE IN XML FORM TO THE MESSAGE OF THE BUSINESS PREMISES TYPE

```
<soapenv:Envelope xmlns:soapenv="http://schemas.xmlsoap.org/soap/envelope/"
xmlns:xsd="http://www.w3.org/2001/XMLSchema" xmlns:fu="http://www.fu.gov.si"
xmlns:ds="http://www.w3.org/2000/09/xmldsig#" xmlns:xsi="http://www.w3.org/2001/XMLSchema-instance">
  <soapenv:Body>
    <fu:BusinessPremiseResponse Id="data">
      <fu:Header>
        <fu:DateTime>2015-08-06T06:40:03.089Z</fu:DateTime>
        <fu:MessageID>8bfbb2b-851c-42fd-80f9-b52d9af85096</fu:MessageID>
      </fu:Header>
      <fu:Errors>
        <fu>Error>
          <fu:ErrorCode>s001</fu:ErrorCode>
          <fu:ErrorMessage>Sporočilo ni v skladu z XML shemo.</fu:ErrorMessage>
        </fu>Error>
      </fu:Errors>
      <Signature xmlns="http://www.w3.org/2000/09/xmldsig#">
        <SignedInfo>
          <CanonicalizationMethod Algorithm="http://www.w3.org/TR/2001/REC-xml-c14n-20010315"/>
          <SignatureMethod Algorithm="http://www.w3.org/2001/04/xmldsig-more#rsa-sha256"/>
          <Reference URI="#data">
            <Transforms>
              <Transform Algorithm="http://www.w3.org/2000/09/xmldsig#enveloped-signature"/>
            </Transforms>
            <DigestMethod Algorithm="http://www.w3.org/2001/04/xmldsig#sha256"/>
          </Reference>
        </SignedInfo>
      </Signature>
    </fu:BusinessPremiseResponse>
  </soapenv:Body>
</soapenv:Envelope>
```

<DigestValue>5KpvJG70yve0S2MrohSypVq7JJ11H6yT88v6q8yYtFk=</DigestValue>  
</Reference>  
</SignedInfo>

<SignatureValue>fj4UTIWOyRRnM9GeCuV+YGgIO2/3+GTuXkxGnhl69DKe0z9rDp3GeBRIL0aXPNSwtfynLwfGmL7n  
kXAqYBiMVoaa0rqA4WKjznZhJK4YsvhHBTxISTMNUSEunSiklqQna5zk2lzTiB+reFgQ/7oUNdTIZqonsi/hU+L/yLPIW1j  
8ABzPB0t8sjXFrrnoZteWq7NjMdxPPdKVSKelFvUuQwlv9B8KOaojrxPSEpvuvhbCZf2wWrv1Squ/+TgsJQuzsbqsp  
giRkY9neWj47LWE4iAGThTMw0n8HDISimrje+Msr  
kReU5e0237+kQpMH5fOWizUbvoiFQVeCzvGCpg==</SignatureValue>

<KeyInfo>

<X509Data>

<X509SubjectName>CN=FURS,2.5.4.5=#130131,OU=77695771,OU=DavPotRacTEST,O=state-  
institutions,C=SI</X509SubjectName>

<X509IssuerSerial>

<X509IssuerName>CN=Tax CA Test,O=state-institutions,C=SI</X509IssuerName>

<X509SerialNumber>4723074879886330622</X509SerialNumber>

</X509IssuerSerial>

<X509Certificate>MIIFXjCCA0agAwIBAgIIQYU7IE8yCv4wDQYJKoZIhvcNAQELBQAwQDELMAkGA1UEBhMCU0kxG  
zAZBgNVBAoMEEnN0YXRILWluc3RpdHV0aW9uczEUMBIGA1UEAwwLVGF4IENBIFRlc3QwHhcNMTUwODAwMTMx  
MjQ3W3hcnMjAwODAwMTMxMjQ3W3JwMQswCQYDVQQGEWJSTEBMBkGA1UECgwSc3RhdGUtaW5zdGloZXRpb  
25zMRYwFAYDVQQQLDA1EYXZQb3RSYWNUURVNUMREwDwYDVQQQLDAg3NzY5NTc3MTEKMAgGA1UEBRMBMT  
ENMAsGA1UEAwwERIVSUzCCASlwdQYJKoZIhvcNAQEBBQADggEPADCCAQoCggEBAIf8jVOE1Je+Jqbs+I+LMK3  
/OUJ/Zj1GbAfdWst/grzKKEh93oelACEvqrJuOZy0qb05NWJ0ra8J4a7DgL4UM7Hzc9Os8TgkT5A7Dh85wIAXgOKk4G  
Di6HliHmaHlaq0ymP2KAvTo3yenmWVclniQYgzbzIDGXbHLTMfHphqtqXDh38rFhFESE8m453mLtzNUOBD7JQbRZ2k5  
XcJtoFOXdwUlwf9KzRm/ue7E3TqEVvuVQ7kucLi5zHoDC6EiF6i/BqAUcNuNyMTBTFixSZnUjOiWgij+DOvFHw36cu4ltr  
WeXL8JHIZy8gvxGNMPJfK4/Ei09OGeMgllUxFtvtiKwGUCAwEAaOCASowggEmMHAGCCsGAQUFBwEBBGGwYj  
A0BggrBgEFBQcwAoYoaHR0cDovL2NhLXRlc3QuZ292LnNpL2NlcnQvVGF4Q0FUZXN0LmNydDAqBggrBgEFBQcw  
AYYeaHR0cDovL29jc3AtdGF4Y2EtdGVzdC5nb3Yuc2kvMB0GA1UdDgQWBBQUVWwSpgf2GcmPag/v/uYMBIFC+yDA  
MBgNVHRMBAf8EAjAAMB8GA1UdIwQYMBaAFDPNWvsJR8cB5jYoJvWbFLeONfeyMBoGA1UdIAQTMBEwDwYnK  
wYBBAGChG+PXwcVATA4BgNVHR8EMTAvmc2gK6AphidodHRwOi8vY2EtdGVzdC5nb3Yuc2kvY3JsL1RheENBVG  
VzdC5jcmwwDgYDVR0PAQH/BAQDAgeAMA0GCSqGSIb3DQEBCwUAA4ICAQBDonBas74WUY8JSOO0/zlSrk2xW  
HIB7jpQsyfyAGrfYUwmA684eWuBqEfpOBx1FimYyT2iURFmwGApXTNfBN6rZyY0LHW6R5N/g0bifsRJZgZBh+SijguO  
tl+yujeNBqmAikwpsUXSyQwuGGOW29LC2n/f5kPaM5cRiXAZx3jkROXTAAHYnjc2//+j8xBU5foA8Z2YG/utl3mqy//FAt  
d1TKmpUmCdMKQ1A7jZIGz8FdB38TPg8OAUfnVQPGgXJJ3sMpk7JXRPRGHHenIRfnOXyukLa62TsG+JTaJ+HEUI  
EAP15Gm0usWdsAZ7oGyD0dPngSEvIT3/8KbYge4bxEOEb20dnz6/6/HZo4gBqT3OZMCK3rzBUlae+/1ALDhGnqOU  
ZEyGAljKggUn/o5K0QrWCHysusmTgefJHNxXPXGgkL0KOcjKNoojSnidaiLW35XoB7QKWObjK8EgJvsHir18f82e3AP3t  
JkBgHu3UD0y/A20Nb4fujWcE337dAHwsVA+DPujN8lanDDNhRnFPutiuc4Y6GMnHSpJfJBqDHTUTNmucrnIT/R0KbPD  
Ds6q/DDICyNxtgdywVDkNHIEYr8U+Q1yIWxsqKp6Kk6/NkAKiiXhFz+XHZx+vaKZ90F7yW+dV5F/zALaXLFuw2Z1m  
axmQFit7S47Usm2e/Hfgg==</X509Certificate>

</X509Data>

<KeyValue>

<RSAKeyValue>

<Modulus>h/yNU4TUI74mpuz4j4swrf85Qn9mPUZsB91ay3+CvMooSH3eh4gAIS+qsm45nLSpvTk1YnStrwnhrsOAvhQ  
zsfNz06zxOCRPKDsOHznCUBeA4qTgYOLqUeWleZoeVqrTKY/YoC9OjfJ6eZZVwieJBiBvOIMZdscu0x8emG2pcOHfy  
sWEURITybjneYu3M1Q4EPsIBtFnaTldwm2gU5d3BQjCJ/0rNGb+7sTdOoRW+5VDuS5yWLnMegMLoSIXqL8GoBRw  
241iZMFMWXFJmdSM6JaCKP4M68UfDfpy7gi2tZ5cvwkchnLyC/EY0w8kWTj8SLT04Z4yCUhTEW1W2lrAZQ==</Mod  
ulus>

<Exponent>AQAB</Exponent>

</RSAKeyValue>

</KeyValue>

</KeyInfo>

</Signature>

</fu:BusinessPremiseResponse>

</soapenv:Body>

</soapenv:Envelope>

## 8. SPOROČILA V JSON OBLIKI / MESSAGES IN JSON FORM

Na voljo je tudi uporaba REST API-ja. Za komunikacijo se uporablja HTTPS protokol. API uporablja metodi POST in GET. Kadar uporabljamo metodo POST, napolnimo telo z JSON objektom. V primeru metode GET, vpišemo parametre v URL. / *Application of REST API is also available. HTTPS protocol is used for communication. API uses POST and GET methods. When we use POST method, we fill the body with JSON object. In cases of GET method, we enter parameters in URL.*

V HTTP header zapišemo tudi tip vsebine / *We include also the content type into HTTP header:*

```
Content-Type = application/json; charset=UTF-8
```

Standard kreiranja JSON telesa / Creation standard of JSON body: <http://json-schema.org/> (shema v prilogi / *schema attached*)

Standard podpisovanja JSON objekta / *Signing standard of JSON object:* <http://www.rfc-editor.org/info/rfc7515>

Za zagotavljanje istovetnosti, je potrebno vsebino, ki jo pošiljamo podpisati s privatnim ključem namenskega digitalnega certifikata. Podpis se izvede po standardu JWS (JSON web signature). / *For purposes of providing identification it is necessary to sign the content, which we send, with the private key of the digital certificate for invoice fiscal verification purposes. The signature is performed on the basis of JWS standard (JSON web signature).*

Sporočilo mora biti v obliki JSON objekta / *Message shall be in the form of JSON object: { "token": "JWT" }.*

JWT(json web token) je sestavljen na sledeč način / *is completed in the following way:*

```
BASE64URL(UTF8(JWS Protected Header)) || '.' ||  
BASE64URL(JWS Payload) || '.' ||  
BASE64URL(JWS Signature)
```

V JWS Protected Header postavimo podatke o načinu podpisovanja in podatek o certifikatu. V JWS Payload postavimo vsebino našega računa/poslovnega prostora. Podpis dobimo tako da z algoritmom SHA256 podpišemo združeno vsebino JWS Protected Header-ja in JWS Payload-a. / *We include data about the signing method and data about the certificate into JWS Protected Header. We include the content of our invoice/business premises into JWS Payload. We get the signature in such a way that we sign the united content of JWS Protected Header and JWS Payload with SHA256 algorithm.*

### 8.1. JWS HEADER

Primer za JWS Header / *Example for JWS Header:*

```
{ "alg": "RS256",  
  "subject_name": "CN=ITM STORITVE\\, SPELA PERGAR S.P.,2.5.4.5=#130131,OU=99999862,O=state-institutions,C=SI",  
  "issuer_name": " CN=Tax CA Test, O=state-institutions, C=SI ",  
  "serial": 2575988469811686647 }
```

Parameter "alg" nam pove vrsto digitalnega podpisa algoritma. Algoritem mora biti "RS256", kar je oznaka za RSA PKCS#1 z SHA-256 hash algoritmom. "Subject\_name", "issuer\_name" in "serial" so podatki iz certifikata. / *»alg« parameter provides the type of algorithm's digital signature. Algorithm shall be "RS256", which is a mark for RSA PKCS#1 with SHA-256 hash algorithm. "Subject\_name", "issuer\_name" and "serial" are data from the certificate.*

V odgovorih s strani ISFU se bo v JWS Header-ju pojavil še parameter "x5c", kateri vsebuje certifikat v base64. / *In responses from ISFU »x5c« parameter will also appear in JWS Header, which includes a certificate in base64.*

Odgovor s strani ISFU bo v obliki JSON objekta / *The response from ISFU will be in the form of JSON object: { "token": "JWT " }.*















```
"issuer_name": "CN=EDB-CA Test,O=MF,C=SI",
"cty": "application/vjson", "typ":
"JOSE", "serial": 3483916479845894172}
```

V formatu base64url ima JWS Header sledečo obliko / *JWS Header has the following form in base64url format:*

```
eyJhbGciOiJSUzI1NiIsInN1YmIiOiJ3aW50OTk5OTk4NjlsTz1zdGF0ZS1pbmN0aXR1dGlvdjbnMsQz1TSSIsImIzIjoiQ049RURCLUNBIFRlc3QsTz1NRixDPVNIiwiaWF0IjoiYXBwbGljYXRpb25cL2pzb24iLCJ0eXAiOiJKT1NIiwic2VyaWFsIjozNDgzOTE2NDc5ODQ1ODk0MTcyfQ
```

Primer za JWS Payload / *Example for JWS Payload:*

```
{
  "BusinessPremiseRequest": {
    "Header": {
      "MessageID": "4e64a93a-40fa-4c02-afb1-488534b85e4c",
      "DateTime": "2015-07-17T09:30:47Z"
    },
    "BusinessPremise": {
      "TaxNumber": 99999862,
      "BusinessPremiseID": "36CF",
      "BPIdentifier": {
        "RealEstateBP": {
          "PropertyID": {
            "CadastralNumber": 365,
            "BuildingNumber": 12,
            "BuildingSectionNumber": 3
          },
          "Address": {
            "Street": "Tržaška cesta",
            "HouseNumber": "24",
            "HouseNumberAdditional": "B",
            "Community": "Ljubljana",
            "City": "Ljubljana",
            "PostalCode": "1000"
          }
        }
      },
      "ValidityDate": "1990-08-25",
      "ClosingTag": "Z",
      "SoftwareSupplier": [
        {
          "TaxNumber": 24564444
        }
      ],
      "SpecialNotes": "Primer prijave poslovnega prostora"
    }
  }
}
```







```
VmaIWY0cmY3ICGlxc6gu0BN-w8vHj6cYQdKVAYAL7oQWst521-  
U5oyajCgJxN2tdpVWJ74tOeNsQS2Y39NzvXk6MIF545J0FxyBQBzPoTdiVjEALcMq2afesCSM7T_CeVj2D9f0ATiuT4ZeGsLg3Yt_tT  
6ZaBjRDOEK9xNok3VD5Csn01_uqh_CXoFJ9tWrbXFOMWJNv_A"}
```

Dekodiramo JWS Payload (drugi del) iz formata base64url ter dobimo sledeče / *We decode JWS Payload (second part) from base64url format and we get:*

Sporočilo ni v skladu s shemo JSON = *Message is not in compliance with JSON schema.*

```
{ "BusinessPremiseResponse": {  
  "Header": {  
    "DateTime": "2015-08-25T13:56:10.311Z",  
    "MessageID": "4e64a93a-40fa-4c02-afb1-488534b85e4c"  
  },  
  "Error": {  
    "ErrorCode": "S002",  
    "ErrorMessage": "Sporočilo ni v skladu s shemo JSON"  }}}
```

## 9.7. PRIMER SPOROČILA TIPA »ECHO« / EXAMPLE OF »ECHO« TYPE MESSAGE

Pošljemo sporočilo s HTTP headerjem / *We send the message with HTTP header Content-Type = application/json; charset=UTF-8.*

Sporočilo / *Message:*

```
POST /v1/cash_registers/echo HTTP/1.1  
Host: blagajne-test.fu.gov.si:9002  
Content-Type: application/json; charset=UTF-8  
{"EchoRequest":"furs"}
```

## 9.8. PRIMER ODGOVORA NA SPOROČILO TIPA »ECHO« / EXAMPLE OF THE RESPONSE TO »ECHO« TYPE MESSAGE

ISFU pošlje kot odgovor naslednje sporočilo / *ISFU sends the following message as the response:*

```
{"EchoResponse": "furs"}
```



## 10. ZAŠČITNA OZNAKA IZDAJATELJA RAČUNA / PROTECTIVE MARK OF THE INVOICE ISSUER

Zaščitna oznaka izdajatelja računa (ZOI) je alfa numeričen zapis, ki ga mora izračunati izdajatelj računa. Prav tako ga mora izpisati na računu in sporočiti na finančno upravo v sporočilu računa. / *The protective mark of the invoice issuer (ZOI) is an alphanumeric record, which shall be calculated by the invoice issuer. This person shall also print it on the invoice and submit it to the financial administration in the invoice message.*

Namen oznake je generiranje enolične oznake, ki pa jo lahko ponovno generira samo izdajatelj računa. Uporablja se tudi za preverjanje pristnosti računa preko spletnega servisa. V tem primeru se uporabi kombinacija ZOI in davčna številka izdajatelja računa. / *The purpose of the mark is generating a uniform mark, which can be generated again only by the invoice issuer. It is used also for checking authenticity of the invoice via the web service. In this case the combination of ZOI and tax number of the invoice issuer is used.*

Da zagotovimo enoličnost kode je potrebno upoštevati nekaj parametrov / *To provide uniformity of the code, it is necessary to take some parameters into consideration:*

1. Enoličnost računa: davčna številka, datum in čas izdaje računa, zaporedna številka računa, oznaka poslovnega prostora, oznaka elektronske naprave izdajatelja računa, znesek računa. / *Uniformity of the invoice: tax number, date and time of issuing the invoice, sequence invoice number, mark of business premises, mark of the electronic device of the invoice issuer, amount of the invoice.*
2. Pristnost izdajatelja: elektronski podpis z namenskim digitalnim potrdilom izdanem s strani MJU za namen davčnega potrjevanja računov / *Authenticity of the issuer: electronic signature with the digital certificate for invoice fiscal verification purposes issued by the MJU for the purpose of fiscal verification of invoices.*

Pri izračunu ZOI-ja se uporablja UTF-8 kodiranje. Pri vnosu skupnega zneska se uporablja decimalna pika (321.45). Za elektronski podpis uporabljamo RSA-SHA256 algoritem za podpisovanje. / *At calculation of ZOI UTF-8 coding is used. At entry of the total amount the decimal dot is used (321.45). We use RSA-SHA256 algorithm for signing for the electronic signature.*

Uporabi se MD5 hash funkcija (po standardu RFC 1321 The MD5 Message-Digest Algorithm), ki vrne rezultat 32 znakovni zapis v hekso formatu. / *MD5 hash function (according to the standard RFC 1321 The MD5 Message-Digest Algorithm) is used, which returns the result 32-character record in hexa notation.*

Primer zaščitne oznake izdajatelja / *Example of issuer's protective mark:*

48c7d8888809f95edae149fa14e17a43

Algoritem za izračun ZOI-ja je možno zapisati kot / *It is possible to record the algorithm for ZOI calculation as:*

MD5hash (elektronsko podpisano s privatnim ključem / *electronically signed with the private key*  
(taxnumber + IssueDateTime + InvoiceNumber + BusinessPremiseID + ElectronicDeviceID  
+InvoiceAmount ))

Sledita dva primera implementacije, eden v Javi, drug pa v .NET tehnologiji. / *There are two examples of implementation, one in Java and the other in .NET technology.*

## 10.1. PRIMER JAVA / JAVA EXAMPLE

Začetek / start Preberi dačno številko / Read the tax number vmesni rezultat = intermediate result  
Čas izdaje računa, ki je naveden na računu = Time of issuing the invoice, which is stated on the invoice  
Preberi zaporedno številko računa = Read the sequence number of the invoice  
Oznaka poslovnega prostora = Mark of business premises  
Preberi oznako elektronske naprave za izdajanje računov = read the mark of the electronic device for issuing invoices  
Preberi skupni znesek računa = read the total amount of the invoice

```
import java.io.FileInputStream;
import java.security.Key;
import java.security.KeyStore;
import java.security.PrivateKey;
import java.security.Signature;
import java.text.SimpleDateFormat;
import java.util.Date;

import org.apache.commons.codec.digest.DigestUtils;

public class zoi {
    public static void main( String[] args ) {
        // začetek

        // preberi davčno številko (taxnumber) / read taxnumber
        String taxnumber = "12345678";

        // vmesni_rezultat = taxnumber
        String vmesni_rezultat = taxnumber;

        //IssueDateTime Datum in čas izdaje računa, ki je naveden na računu / Date and time of issuing the invoice,
        //which is stated on the invoice
        String IssueDateTime = new SimpleDateFormat( "dd.MM.yyyy HH:mm:ss" ).format(new Date());
        vmesni_rezultat = vmesni_rezultat + IssueDateTime;

        // preberi zaporedno številko računa: InvoiceNumber / read Sequence number of the invoice: InvoiceNumber
        String InvoiceNumber = "12345";

        vmesni_rezultat = vmesni_rezultat + InvoiceNumber;

        // preberi (BusinessPremiseID – Oznaka poslovnega prostora) / read (BusinessPremiseID – Mark of business
        //premises)
        String BusinessPremiseID = "blag001";

        // vmesni_rezultat = vmesni_rezultat + poslovni_prostor
        vmesni_rezultat = vmesni_rezultat + BusinessPremiseID;

        // preberi oznako elektronske naprave za izdajanje računov: ElectronicDeviceID / read mark of the electronic
        device: ElectronicDeviceID)
        String ElectronicDeviceID = "11245";

        vmesni_rezultat = vmesni_rezultat + ElectronicDeviceID;

        // preberi skupni znesek računa: InvoiceAmount / read value of the invoice: InvoiceAmount
```

```
String InvoiceAmount = "1245.56";
```

```
vmesni_rezultat = vmesni_rezultat + InvoiceAmount;
// elektronsko podpiši vmesni_rezultat z RSA-SHA256 / digitally sign vmesni_rezultat using RSA-SHA256
byte[] podpisano = null;
try {
    FileInputStream file_inputstream = new FileInputStream("clientcert.jks");
    KeyStore keyStore = KeyStore.getInstance(KeyStore.getDefaultType());
    keyStore.load(file_inputstream, "futeest".toCharArray());
    String alias = "itm storitve\\, špela pergár s.p.";
    Key privateKey = keyStore.getKey( alias, "futeest".toCharArray());

    Signature podpis = Signature.getInstance("SHA256withRSA");
    podpis.initSign((PrivateKey)privateKey);
    podpis.update(vmesni_rezultat.getBytes());
    podpisano = podpis.sign();
}
catch ( Exception e ) {
    // napaka / error
    e.printStackTrace();
}

// zoi = izračunajMD5(elektronsko podpisan vmesni_rezultat) / zoi = calculateMD5(digitally signed
// vmesni_rezultat)
String zoi = DigestUtils.md5Hex(podpisano);

// konec / end
System.out.println("32-mestni ZOI je: " + zoi);
}
}
```

## 10.2. PRIMER .NET (C#)

```
using System;
using System.Collections.Generic;
using System.Text;
using System.Security.Cryptography;
using System.Security.Cryptography.X509Certificates;

class ZOI
{
    public static string Izracunaj(string[] args, X509Certificate2 certifikat)
    {
        // začetek / begin
        // preberi (TaxNumber) / read (TaxNumber)
        string TaxNumber = args[0];
        string vmesni_rezultat = TaxNumber;

        // preberi (IssueDateTime - datum in čas izdaje računa, ki je naveden na računu
        // 'dd.MM.yyyy HH:mm:ss') / read (IssueDateTime - Date and time of issuing the invoice,
        // which is stated on the invoice // 'dd.MM.yyyy HH:mm:ss')
        string IssueDateTime = args[1];
        vmesni_rezultat = vmesni_rezultat + IssueDateTime;
    }
}
```

```

    // preberi (InvoiceNumber - Zaporedna številka računa) / read (InvoiceNumber - Sequence
// number of the invoice)
    string InvoiceNumber = args[2];
    vmesni_rezultat = vmesni_rezultat + InvoiceNumber;
    // preberi (BusinessPremiseID - Oznaka poslovnega prostora) / read (BusinessPremiseID -
// Mark of business premises)
    string BusinessPremiseID = args[3];
    vmesni_rezultat = vmesni_rezultat + BusinessPremiseID;
    // preberi (ElectronicDeviceID - Oznaka elektronske naprave za izdajanje računov) / read
// (ElectronicDeviceID - Mark of the electronic device)
    string ElectronicDeviceID = args[4];
    vmesni_rezultat = vmesni_rezultat + ElectronicDeviceID;
    // preberi (InvoiceAmount - Vrednost računa) / read (InvoiceAmount - Value of the
//invoice)
    string InvoiceAmount = args[5];
    vmesni_rezultat = vmesni_rezultat + InvoiceAmount;

    //elektronsko podpiši vmesni_rezultat z uporabo RSA_SHA256 / digitally sign
//vmesni_rezultat using RSA_SHA256
    try
    {

        byte[] podatki = Encoding.ASCII.GetBytes(vmesni_rezultat);

        // Za izvedbo podpisa z uporabo sha256 je potrebna pretvorba v "Microsoft Enhanced
// RSA and AES Cryptographic Provider"
        //, če je digitalno potrdilo prevzeto v "Microsoft Enhanced Cryptographic Provider
// v1.0"
        // For digital signature using sha256 conversion into "Microsoft Enhanced // RSA //
//and AES Cryptographic Provider" is needed
        //, if certificate was stored into "Microsoft Enhanced Cryptographic Provider v1.0"
        RSACryptoServiceProvider rsaCSP = (RSACryptoServiceProvider)certifikat.PrivateKey;
        CspParameters cspParameters = new CspParameters();
        cspParameters.KeyContainerName = rsaCSP.CspKeyContainerInfo.KeyContainerName;
        cspParameters.KeyNumber = rsaCSP.CspKeyContainerInfo.KeyNumber == KeyNumber.Exchange

? 1 : 2;

        RSACryptoServiceProvider rsaAesCSP = new RSACryptoServiceProvider(cspParameters);
        byte[] signature = rsaAesCSP.SignData(podatki, CryptoConfig.MapNameToOID("SHA256"));

        MD5 md5Hash = MD5.Create();
        string rezultat = GetMd5Hash(md5Hash, signature);

        // konec / end
        //Console.WriteLine(rezultat);
        return rezultat;
    }
    catch (Exception ex)
    {
        // napaka / error
        Console.WriteLine(ex.Message);
        return ex.Message;
    }
}

// Metoda za izračun MD5 hash / Method for calculation of MD5 hash
private static string GetMd5Hash(MD5 md5Hash, byte[] input)
{
    byte[] data = md5Hash.ComputeHash(input);
    StringBuilder sBuilder = new StringBuilder();

```

```
    for (int i = 0; i < data.Length; i++)
    {
        sBuilder.Append(data[i].ToString("x2"));
    }
    return sBuilder.ToString();
}
}
```